

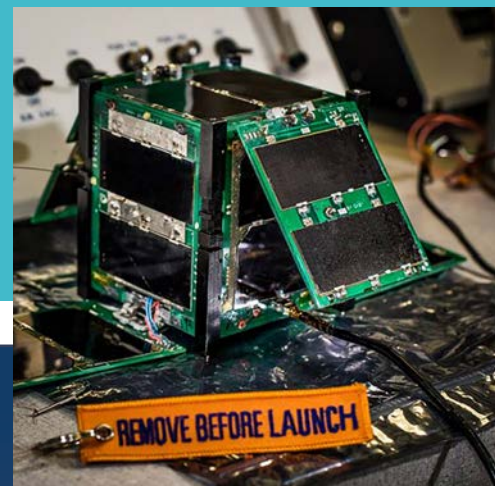

CubeSat 101

Basic Concepts and Processes for
First-Time CubeSat Developers

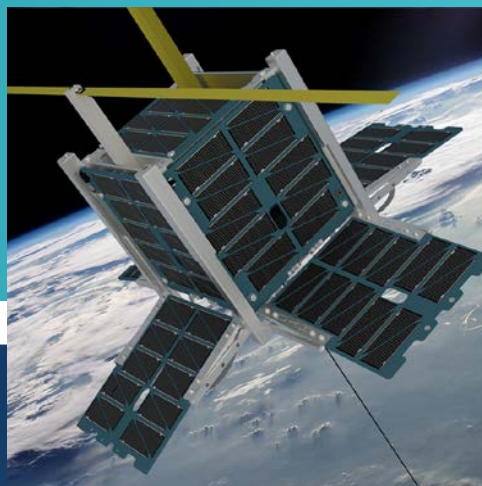

CubeSat 101

Basic Concepts and Processes for
First-Time CubeSat Developers

NASA CubeSat Launch Initiative

For Public Release – Revision Dated October 2017

Produced under contract by the

California Polytechnic State University, San Luis Obispo (Cal Poly) CubeSat Systems Engineer Lab

Acknowledgements

This guide was produced by the following to support NASA's CubeSat Launch Initiative:

Writers and Contributors

California Polytechnic's PolySat Program, California Polytechnic State University— San Luis Obispo

Jamie Chin
Roland Coelho
Justin Foley
Alicia Johnstone
Ryan Nugent
Dave Pignatelli
Savannah Pignatelli
Nikolaus Powell
Jordi Puig-Suari

NASA Launch Services Program

William Atkinson, Kennedy Space Center
Jennifer Dorsey, Kennedy Space Center
Scott Higginbotham, Kennedy Space Center
Maile Krienke, Kennedy Space Center
Kristina Nelson, Kennedy Space Center/ai Solutions
Bradley Poffenberger, Kennedy Space Center
Creg Raffington, Kennedy Space Center
Garrett Skrobot, Kennedy Space Center
Justin Treptow, Kennedy Space Center
Anne Sweet, NASA Headquarters

NASA Advanced Exploration Systems Division

Jason Crusan, NASA Headquarters
Carol Galica, NASA Headquarters/Stellar Solutions

NASA Space Communications and Navigation Division

William Horne, NASA Headquarters Space
Communications and Navigation Spectrum
Management

NASA Jet Propulsion Laboratory

Charles Norton, Jet Propulsion Laboratory
Formulation Lead for Small Satellites

NOAA

Alan Robinson, NOAA Commercial Remote Sensing
Regulatory Affairs Office

Editors and Graphic Designer

Communications Support Services Center

Maxine Aldred, NASA Headquarters/Media Fusion
Andrew Cooke, NASA Headquarters/Media Fusion
Tun Hla, NASA Headquarters/Media Fusion
Michele Ostovar, NASA Headquarters/Media Fusion
Jennifer Way, NASA Headquarters/Media Fusion

For more information visit: http://go.nasa.gov/CubeSat_initiative



Table of Contents

Acknowledgments ii

Pictured above:
NASA mentors and the student launch team for **StangSat** and **PolySat** go through final checks in the CubeSat lab facility at Cal Poly. [VAFB/Kathi Peoples]

1 Introduction 1

- 1.1 CubeSats. 4
- 1.2 CubeSat Dispenser Systems 4
 - 1.2.1 3U Dispensers 5
 - 1.2.2 6U Dispensers 6
- 1.3 Launch Vehicles (LVs)—aka: Rockets 6

2 Development Process Overview 9

- 2.1 Concept Development (1–6 months) 11
- 2.2 Securing Funding (1–12 months) 11
- 2.3 Merit and Feasibility Reviews (1–2 months) 14
- 2.4 CubeSat Design (1–6 months) 15
- 2.5 Development and Submittal of Proposal in Response to CSLI Call (3–4 months). 17
- 2.6 Selection and Manifesting (1–36 months) 18
- 2.7 Mission Coordination (9–18 months) 19
- 2.8 Regulatory Licensing (4–6 months) 20
- 2.9 Flight-Specific Documentation Development and Submittal (10–12 months). 21

2.10	Ground Station Design, Development, and Testing (2–12 months).	22
2.11	CubeSat Hardware Fabrication and Testing (2–12 months).	23
2.12	Mission Readiness Reviews (Half-Day)	25
2.13	CubeSat-to-Dispenser Integration and Testing (2 days)	26
2.14	Dispenser-to-Launch Vehicle Integration (1 day).	27
2.15	Launch (1 day)	28
2.16	Mission Operations (variable, up to 20 years)	29
3	Mission Models	31
3.1	NASA-Procured Launch Vehicle Mission Model.	32
3.2	Operationally Responsive Space (ORS) Rideshare Mission Model	34
3.3	National Reconnaissance Office (NRO) Rideshare Mission Model	35
3.4	Commercial Launch Service Through a Third-Party Broker Mission Model	37
3.5	International Space Station (ISS) Deployment Mission Model	38
4	Requirement Sources for Launch	39
4.1	Mission-Specific Interface Control Documents (ICDs)	40
4.2	Launch Services Program (LSP)— Program-Level Requirements.	40
4.3	CubeSat Design Specifications (CDS).	40
4.4	Dispenser Standards/Specifications	41
4.5	Federal Statutes	41
4.6	Range Safety Requirements	42
5	Licensing Procedures	43
5.1	Radio Frequency (RF) Licensing	43
5.2	Remote Sensing	51

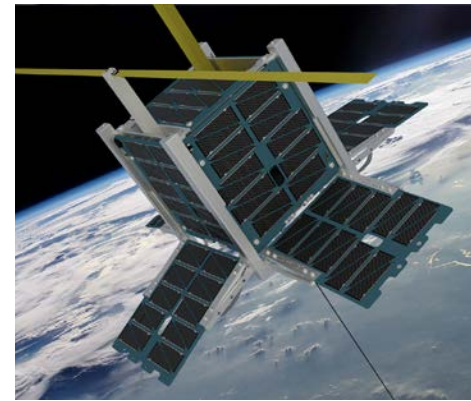

ChargerSat-1's mission was developed by students from the University of Alabama, Huntsville to conduct three technology demonstrations: a gravity gradient stabilization system will passively stabilize the spacecraft; deployable solar panels will nearly double the power input to the spacecraft; and the same deployable solar panels will shape the gain pattern of a nadir-facing monopole antenna, allowing improved horizon-to-horizon communications. [University of Alabama, Huntsville]

6	Flight Certification Documentation	53
<hr/>		
6.1	Orbital Debris Mitigation Compliance	54
6.2	Transmitter Surveys.	55
6.3	Materials List	55
6.4	Mass Properties Report	56
6.5	Battery Report	57
6.6	Dimensional Verifications	57
6.7	Electrical Report	58
6.8	Venting Analysis	58
6.9	Testing Procedures/Reports	59
6.9.1	<i>Day In The Life (DITL) Testing</i>	59
6.9.2	<i>Dynamic Environment Testing (Vibration/Shock)</i>	60
6.9.3	<i>Thermal Vacuum Bakeout Testing</i>	62
6.10	Compliance Letter	64
6.11	Safety Package Inputs (e.g., Missile System Prelaunch Safety Package, Flight Safety Panel)	64

	Appendices	65
<hr/>		
A	List of Abbreviations	65
B	Glossary	66
C	Templates	69
1.	<i>ODAR Inputs</i>	69
2.	<i>CubeSat Components ODAR Template</i>	71
3.	<i>Transmitter Survey</i>	72
4.	<i>Materials List</i>	74
5.	<i>Compliance Letter</i>	77
6.	<i>CubeSat Acceptance Checklists</i>	79
D	Technical Reference Documents for CubeSat Requirements.	84
E	Notional Timeline of Events/Deliverables	85

1

Introduction

IN THIS CHAPTER

- 1.1 CubeSats
- 1.2 CubeSat Dispenser Systems
 - 1.2.1 3U Dispensers
 - 1.2.2 6U Dispensers
- 1.3 Launch Vehicles (LV), aka: Rockets

How do you start a CubeSat project? As popular as CubeSats have become, it's surprising how little information is out there to help someone just entering the field. That's why this document was created—to lay out everything you need to take a great CubeSat idea and make it into an actual spacecraft that is launched into orbit. If you've been involved in the CubeSat world for a while, this guide will be a good reference for anything on which you might need a refresher. However, this guide is written for first-time CubeSat developers, and especially for CubeSats being developed at educational institutions. So, if this is your first foray into CubeSats, you'll want to read through carefully to get an idea of the scope and the amount of work this project will require.

Before we get to the nitty-gritty, let's start with a little background. CubeSats began as a collaborative effort in 1999 between Jordi Puig-Suari, a professor at California Polytechnic State University (Cal Poly), and Bob Twiggs, a professor at Stanford University's Space Systems Development Laboratory (SSDL). The original intent of the project was to provide affordable access to space for the university science community, and it has successfully done so. Thanks to CubeSats, many major universities now have a space program. But it's not just big universities; smaller universities, high schools, middle schools, and elementary schools have also been able to start CubeSat programs of their own.

FIGURE 1 shows university students in their clean room taking measurements of a CubeSat they helped to develop. In addition to educational institutions, Government agencies and

Pictured above:

Launch of NASA's National Polar-orbiting Operational Environmental Satellite System (NPOESS) Preparatory Project (NPP) mission on Oct. 28, 2011, which deployed five CubeSats as part of the Educational Launch of Nanosatellites (ELaNa)-III Mission. [U.S. Air Force/Staff Sgt. Andrew Satran]



FIGURE 1: University student taking measurements of a 2U CubeSat (CP9). [Cal Poly]

commercial groups around the world have developed CubeSats. They recognized that the small, standardized platform of the CubeSat can help reduce the costs of technical developments and scientific investigations. This lowered barrier to entry has greatly increased access to space, leading to an exponential growth in the popularity of CubeSats since their inception. In addition, this world of small, affordable spacecraft has gotten more diverse and complicated each year, as more and more researchers find utility in these small packages.

This document was created mainly for **CubeSat developers** who are working with NASA's CubeSat Launch Initiative (CSLI), but most chapters also will be useful to CubeSat developers launching through other organizations.

What's CSLI, you ask? CSLI is a NASA initiative that provides opportunities for qualified CubeSats to fly as auxiliary payloads on future launches that have excess capacity or as deployments from the International Space Station (ISS). In very simple terms that means that NASA will cover the cost of providing your CubeSat a ride to space in exchange for a report on the results of your CubeSat investigation.

CSLI enables NASA to develop public-private partnerships that provide a low-cost platform for NASA science missions, including planetary exploration, Earth

CubeSat developer: You'll hear this term a lot in the CubeSat world. This is the standard term for any person or organization that is designing, building, and preparing a CubeSat for flight.

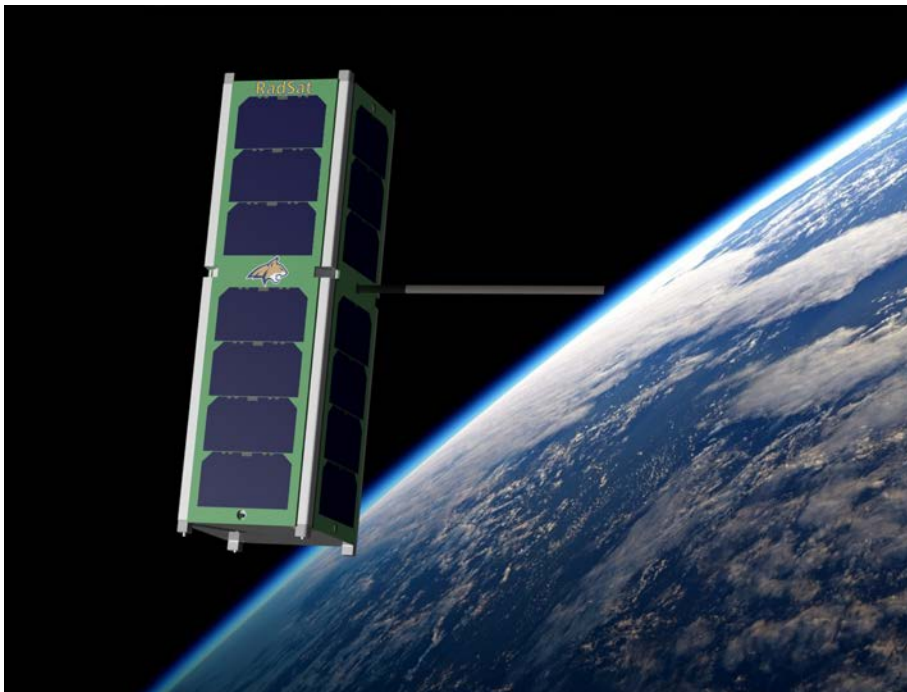
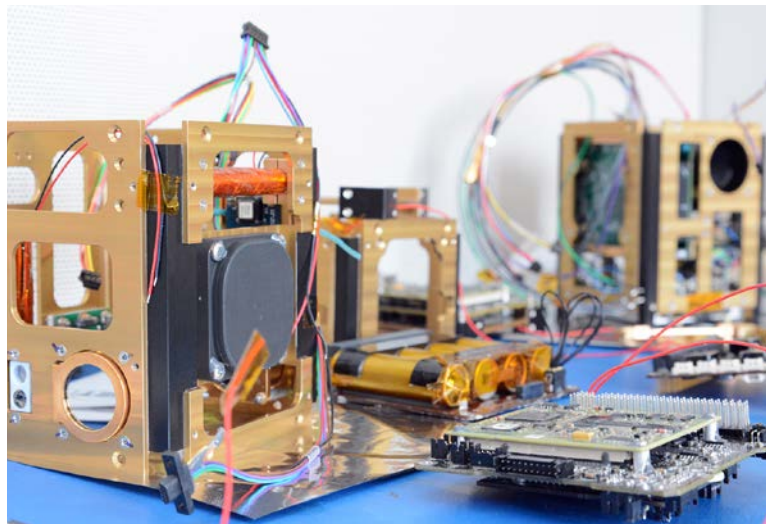

Illustration of ELaNa 23 **RadSat-G** CubeSat from Montana State University in orbit around Earth. [Montana State University]

observation, and fundamental Earth and space science. These efforts are a cornerstone in the development of cutting-edge NASA enabling technologies including laser communications, next generation avionics approaches, power generation, distributive sensor systems, satellite-to-satellite communications, and autonomous movement. Leveraging these missions for collaboration optimizes NASA's technology investments, fosters open innovation, and facilitates technology infusion. CubeSat missions are enabling the acceleration of flight-qualified technology assistance in raising Technology Readiness Levels, which aligns to NASA's objective of advancing the Nation's capabilities by maturing cross-cutting innovative space technologies.



ARMADILLO (Attitude Related Maneuvers And Debris Instrument in Low (L) Orbit) is a 3U CubeSat under development at the University of Texas at Austin. [University of Texas at Austin]

About half of all CSLI missions are conducting scientific investigations, most frequently Space Weather and Earth Science. Specific science investigation areas include: biological science, study of near Earth objects, climate change, snow/ice coverage, orbital debris, planetary science, space-based astronomy, and heliophysics. Sixty-six percent of all CSLI missions are conducting technology development or demonstrations. Communications, propulsion, navigation and control, and radiation testing lead the topics in this area. Other notable technologies are solar sails, additive manufacturing, femtosatellites, and smart phone satellites. The low cost of development for a CubeSat allows for conducting higher risk activities that would not be possible on large-scale NASA missions.

To be eligible for CSLI, your CubeSat **investigation** must be of clear benefit to NASA by supporting at least one goal or objective stated in the NASA Strategic Plan. This plan can be found on NASA's Web site (<http://www.nasa.gov>). Each year—typically in early August—the CSLI solicits proposals through an Announcement of Opportunity (AO) on the Federal Business Opportunities Web site (<https://www.fbo.gov>); proposals are typically due in November of that same year.

If you'd like to read more about CSLI, their Web page can be found at http://go.nasa.gov/CubeSat_initiative.

investigation: This term gets used often when talking about a CubeSat's mission. It refers to the investigation, scientific or otherwise, that your CubeSat will be performing. In this context, "investigation" is commonly used interchangeably with a CubeSat "mission."



1.1 CubeSats

Let's explain what the "CubeSat" designation means, compared to other small satellites. A small satellite is generally considered to be any satellite that weighs less than 300 kg (1,100 lb). A CubeSat, however, must conform to specific criteria that control factors such as its shape, size, and weight.

The very specific standards for CubeSats help reduce costs. The standardized aspects of CubeSats make it possible for companies to mass-produce components and offer off-the-shelf parts. As a result, the engineering and development of CubeSats becomes less costly than highly customized small satellites. The standardized shape and size also reduces costs associated with transporting them to, and deploying them into, space.

CubeSats come in several sizes, which are based on the standard CubeSat "unit"—referred to as a 1U. A 1U CubeSat is a 10 cm cube with a mass of approximately 1 to 1.33 kg. In the years since the CubeSat's inception, larger sizes have become popular, such as the 1.5U, 2U, 3U, and 6U, but new configurations are always in development. Examples of a 1U and 3U are shown in **FIGURE 2**.

To get a better idea of the design requirements, take a look at the **CubeSat Design Specification (CDS)** at <http://www.cubesat.org>. We'll explain more about the CDS and the documents you will need in the Requirements Sources chapter. For now, checking out the CDS at the CubeSat Web site is a great place to start your preliminary design planning.

1.2 CubeSat Dispenser Systems

We've described the CubeSat itself, but there's another important piece of the puzzle: the dispenser, which is the interface between the CubeSat and the launch vehicle (LV). The dispenser provides attachment to a launch vehicle (or rocket), protects the CubeSat during launch, and releases it into space at the appropriate time.

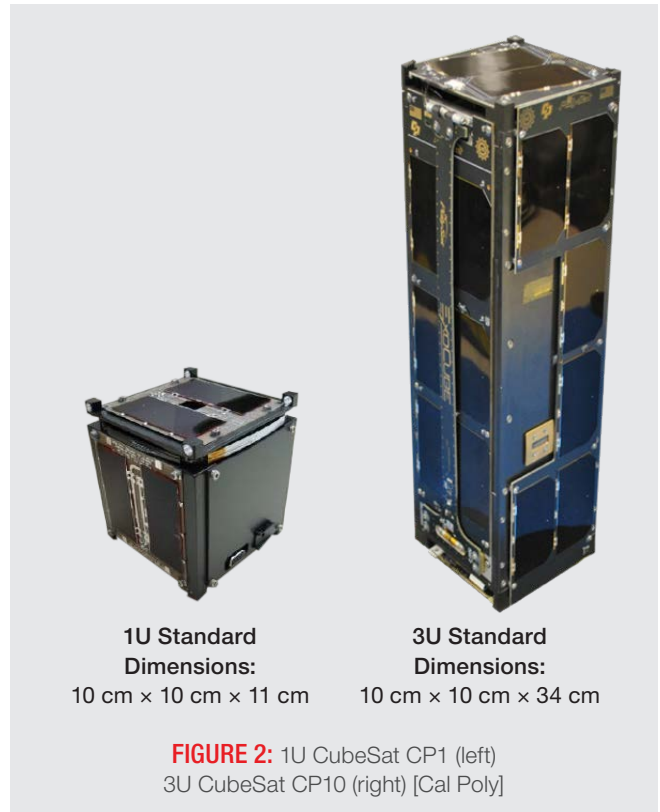

CDS: The CDS is a set of general requirements for all CubeSats, but is not the official set of requirements that you will need to follow for your launch.



There are a number of different types of dispensers on the market. Each has different features, but they are all designed to hold satellites that conform to the standard CubeSat **form factor**.

Chances are you won't be choosing the dispenser for your CubeSat; that honor will go to whoever is footing the bill for the launch costs. It's still important to understand the **interface** between your CubeSat and the launch vehicle. To that end, this chapter will outline the types of dispensers with which you are likely to work.

1.2.1 3U Dispensers

The first dispenser for CubeSats was the Poly-Picosatellite Orbital Deployer (P-POD). It was developed by Cal Poly, San Luis Obispo. The current revision of the P-POD is pictured in **FIGURE 3**. It can hold up to three Us of CubeSat **payload(s)** (meaning any combination that adds up to three Us, such as three 1Us, two 1.5Us, one 3U, etc.) and bolts directly onto the launch vehicle. When it's time to release the payload, the launch vehicle sends an electrical signal to the P-POD, which causes the door to open and release the CubeSat(s) into orbit. Although most dispensers on the market have different designs, they all tend to follow the same basic idea of a safe container with a door that opens at the launch vehicle's command, which then ejects the CubeSat into space.



FIGURE 3: Poly-Picosatellite Orbital Deployer (P-POD) Developed by Cal Poly, San Luis Obispo. [Cal Poly]

In the beginning, the P-POD may have been the only option for CubeSats, but now there are several dispenser choices. The manufacturers and vendors are easy to find; just type keywords like “CubeSat dispenser” into your favorite search engine and start clicking! Even though you might not have the final say in which dispenser you use, you should take some time to understand the different dispensers on the market and the kinds of features that are available before you start designing your CubeSat.

form factor: This is a term used to describe the size, shape, and/or component arrangement of a particular device. When we use it in reference to the standard CubeSat, we're referring to the specific size and mass that defines a CubeSat.

interface: “Interface” is a general term that refers to any point where two or more components are joined together. For instance, someone may ask, “How does the CubeSat interface with the dispenser?” or, “Is there an electrical interface between the CubeSat and the Dispenser?” (These questions mean, “Can I electrically connect the CubeSat to the dispenser somehow?”)

payload: In the aerospace industry, “payload” is a general term used to describe the cargo (e.g., a satellite or spacecraft) being delivered to space. When we're talking about CubeSat dispensers, the payload always refers to the CubeSat.



1.2.2 6U Dispensers

After a number of successful launches using the 3U dispenser, developers quickly started planning for the next stage of CubeSat design: let's make them bigger! And thus in 2014, the 6U was born. The form factor of the 6U is essentially the same as two 3Us side-by-side, making it twice as wide. You can see an example of a 6U CubeSat in **FIGURE 4**. Multiple companies within the industry have developed dispensers to accommodate the larger size. And—you guessed it—those companies can be found with a simple Internet search. The 6U dispensers' features vary, but most allow for any CubeSat configuration (e.g., one 6U, six 1Us, two 3Us, etc.), and function similarly to the 3U dispensers.

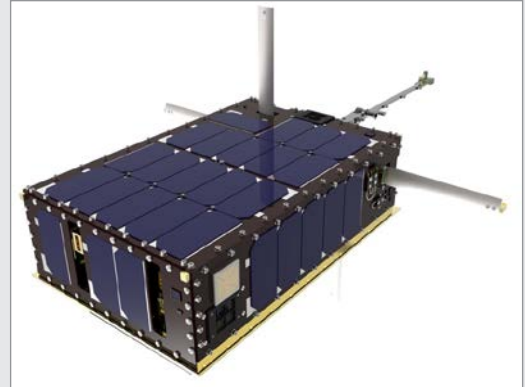

FIGURE 4: Example of a 6U CubeSat (Dellingr CubeSat) [NASA]

1.3 Launch Vehicles (LVs)—aka: Rockets

Finally, let's talk about how the dispenser which contains your CubeSat will get into orbit. CSLI contracts with multiple launch services that allow CubeSats to hitch a ride. When the CubeSat/dispenser package was first dreamed up, the idea was to bolt the dispenser onto the rocket where space was available. That is still how most CubeSats make the journey, although there are now other options



Students Jacob Hambur and Trisha Joseph from the University of Central Florida constructing the **Q-PACE** CubeSat. [University of Central Florida]

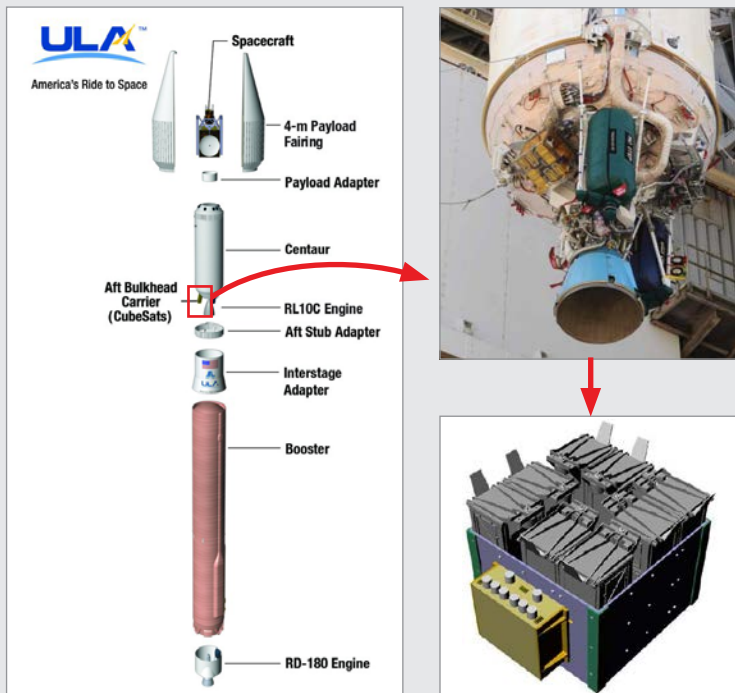

FIGURE 5: This United Launch Alliance (ULA) image shows where on the launch vehicle the CubeSats might be located for a typical ULA CubeSat mission. The inset pictures show a Naval Postgraduate School Cubesat Launcher Lite (NPSCuL-Lite) housing eight 3U P-PODs and attached to the LV via an Aft Bulkhead Carrier (ABC) plate. [United Launch Alliance]

available (see **FIGURE 5**). For example, a CubeSat can be sent with the cargo on a resupply mission to the Space Station. The CubeSat would be taken aboard the Space Station and released into space in a specially designed deployer.

You also may forgo the dispenser altogether, like the Peruvian Chasqui 1 did in 2014. During a spacewalk, a cosmonaut released Chasqui 1 from the Space Station by tossing it by hand into orbit. There’s even a video of this online! **FIGURE 6** is a still from that video. Keep in mind that although it has been done, this type of release is extremely uncommon.



FIGURE 6: Russian cosmonaut preparing to launch a 1U CubeSat that he is holding in his hand. [NASA]

U.S. Launch Vehicles Used for CubeSat Launch

- Super Strypi
- Minotaur I
- Minotaur IV
- Taurus XL
- Delta II
- Antares
- Falcon 9
- Atlas V
- Electron*
- Falcon 9 Heavy*
- LauncherOne*
- Space Launch System (SLS)*

* These launch vehicles have not flown CubeSats as of the writing of this document in 2017, but have included CubeSats in the manifests of upcoming flights.

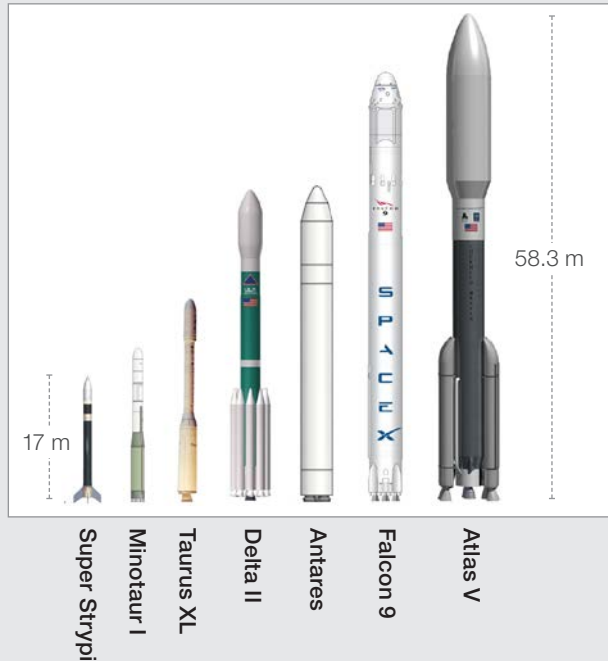

FIGURE 7: U.S. Launch Vehicles Used for CubeSat Launches.

FIGURE 7 shows all of the launch vehicles that have taken CSLI CubeSats to orbit as of the writing of this document in 2017, as well as launch vehicles that are planning to carry their first set of CubeSats on a future launch. Your CubeSat is by no means limited to the launch vehicles included on this list; any rocket could be a potential CubeSat launch vehicle given the right circumstances. The launch vehicle has to have additional performance margin, be going to your desired orbit, and can adapt to having dispensers installed.

2 Development Process Overview

IN THIS CHAPTER

- 2.1 Concept Development
- 2.2 Securing Funding
- 2.3 Merit and Feasibility Reviews
- 2.4 CubeSat Design
- 2.5 Development and Submittal of Proposal in Response to CSLI Call
- 2.6 Selection and Manifesting
- 2.7 Mission Coordination
- 2.8 Regulatory Licensing
- 2.9 Flight Specific Documentation Development and Submittal
- 2.10 Ground Station Design, Development, and Testing
- 2.11 CubeSat Hardware Fabrication and Testing
- 2.12 Mission Readiness Reviews
- 2.13 CubeSat-to-Dispenser Integration and Testing
- 2.14 Dispenser-to-Launch Vehicle Integration
- 2.15 Launch
- 2.16 Mission Operations

This chapter will tell you everything you need to accomplish and provide an estimated timeline of how long it may take to get your CubeSat from a concept to a functioning satellite in orbit. We may be focusing on what you need to do specifically for CSLI, but the process for any CubeSat **mission** will be very similar. The overall timeframe can vary depending on the launch vehicle selected and what you are trying to accomplish with your CubeSat. A CubeSat can be designed, built, tested, and delivered in as little as 9 months, but typically takes 18 to 24 months to complete. Once your CubeSat is ready to be delivered, the typical time to launch is anywhere from a few months to a few years. This is obviously affected by the availability of launch opportunities, but also by the flexibility of your orbital requirements—the more flexible, the easier to manifest and therefore, the shorter wait. Launch vehicles will usually require you to deliver your finished CubeSat between 4 weeks and 6 months prior to launch; again, this depends on the launch vehicle provider and the organization sponsoring your launch.

The project phases (and typical timeframes) are as follows:

1. Concept Development (1–6 months)
2. Securing Funding (1–12 months)
3. Merit and Feasibility Reviews (1–2 months)
4. CubeSat Design (1–6 months)
5. Development and Submittal of Proposal in Response to CSLI Call (3–4 months)

Pictured above:

CSUNSat-1 Team (Adam Kaplan, James Flynn, Donald Eckels) working on their CubeSat. [CSU-Northridge]

mission: This term is a somewhat generic, all-encompassing term that refers to the enterprise as a whole. It's sometimes used interchangeably with “project” or “investigation” and includes all phases from development, testing, integration, to launch and operations.

6. Selection and Manifesting (1–36 months)
7. Mission Coordination (9–18 months)

Once this phase begins, a schedule will be provided by the integrator that will dictate hardware and documentation delivery dates, essentially providing the completion dates for the subsequent phases.
8. Licensing (4–6 months)
9. Flight-Specific Documentation Development and Submittal (10–12 months)
10. Ground Station Design, Development, and Testing (2–12 months)
11. CubeSat Hardware Fabrication and Testing (2–12 months)
12. Mission Readiness Reviews (half-day)
13. CubeSat to Dispenser Integration and Testing (1 day)
14. Dispenser to Launch Vehicle Integration (1 day)
15. Launch (1 day)
16. Mission Operations (variable, up to 20 years)

Note: **FIGURE 8** and *Appendix E* provide a notional timeline of events and deliverables. It will give you an idea of the timeframes that can overlap if your resources permit.

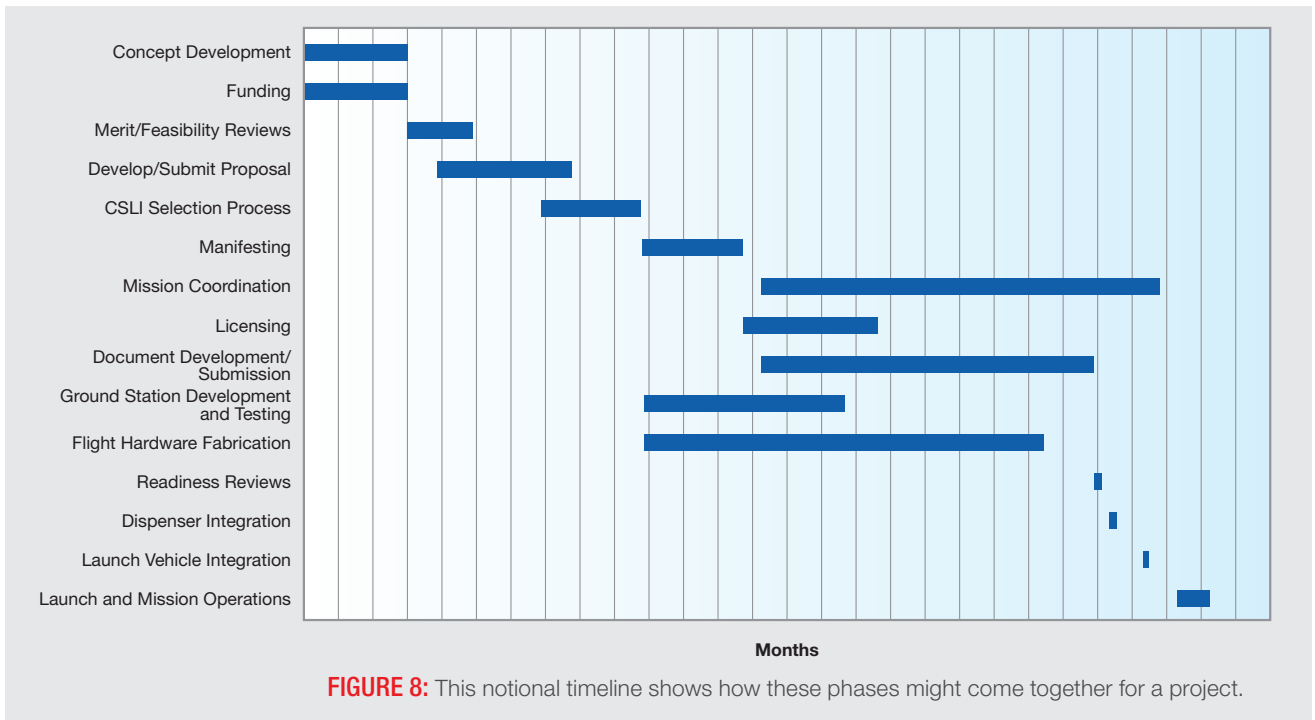

2.1 Concept Development (1–6 months)

Okay, first things first: What do you want your CubeSat to do? As we mentioned in [Chapter 1](#), it is important to choose a mission goal in which the CSLI, that is, NASA, will be interested. You may also consider choosing a concept for which it will be easy to find funding. Many CubeSat missions are designed around the goals of a sponsor who will cover most of the development costs (more on that in [Chapter 2.2](#)). For your best chance of being selected by CSLI, check off as many “Keys to CSLI Selection” (see the “Free Advice” inset on the right) as you can.

There’s no real time limit to this early concept development phase. Typically, a CubeSat developer will take anywhere from 1 to 6 months to plan the goals and basic details of the CubeSat concept.

By the way, there’s no need to go it alone. Part of this conceptual development time will be spent in search of possible partners and collaborators who may have goals similar to your own. This is called **strategic partnering**, and may provide you with extra funding or expertise, or both.

2.2 Securing Funding (1–12 months)

WARNING!

Under CSLI, NASA will cover all costs associated with the launch (up to \$300,000, typically enough to launch a 3U into low-Earth orbit), but **CubeSat developers selected for a CSLI flight are responsible for any and all expenses related to the development and operation of the CubeSat**. This includes all materials and labor required to build the CubeSat, plus the testing expenses, ground station development and operational expenses, as well as travel costs for required CSLI meetings and delivery.

➔ **Money is very important.** Once your CubeSat is selected and manifested for a flight, CSLI will begin spending NASA dollars on your behalf. If you run out of funds and cannot complete your CubeSat, NASA may not be able to apply completed activities (“sunk costs”) to a replacement CubeSat. If this happens, a launch opportunity will have been lost and it could even cause the demanifest of other CubeSats co-manifested on the same launch. Additionally, the Cooperative Research and Development Agreement (CRADA) that you sign with NASA after being manifested requires you to reimburse NASA for any integration and launch

> FREE ADVICE

FLEXIBILITY IS KEY. Keep your mission as flexible as possible. CSLI may select your CubeSat mission because it has some great science goals, but that doesn’t guarantee you’ll get a launch right away. If you need special considerations like a very specific orbit or specific launch date, finding a launch could be tricky. Do your best to keep your requirements for launch as flexible as possible.

Keys to CSLI Selection

- Adequate funding
- Great merit and feasibility reviews
- Clear demonstration of benefit to NASA

strategic partnering:

Sometimes a CubeSat mission is too ambitious for a single organization to undertake. In that case, a strategic partnership can combine the strengths and resources of multiple organizations to achieve greater goals. These strategic partnerships are typically formalized by some kind of formal agreement.

costs incurred if you don't deliver your CubeSat on time. This hasn't happened to anyone yet, but it could! Therefore, **do not accept a launch opportunity until you are confident you can deliver your CubeSat on time.** As part of your proposal to CSLI, you will need to provide enough budgetary information to prove that you've secured enough funding to get you across the finish line.

That being said, there is *plenty* of money out there for CubeSat projects, you just need to know where to look. Let's take a look at where you can get the money you need for your space mission!

Designing a CubeSat around a specific mission you came up with on your own may be your dream, but it may be difficult to find funding. There are, however, requests for proposals (RFPs) sent out every year from organizations looking for people who can help them perform missions that would be perfect for a CubeSat. The National Science Foundation has funded a number of CubeSats in the past, as has NASA's Earth Science Technology Office (ESTO). A simple Internet search could help you find similar organizations looking for a great team to help them out. These organizations would work with your team and cover some or all of the development costs. For university students interested in starting a CubeSat project, another option is to inquire with faculty and administrators at your college or university. Someone there may think that funding your project would be an impressive feather in the university's cap. In addition, every state has a NASA *Space Grant Consortium*, which provides resources in support of students pursuing careers in science, technology, engineering, and mathematics, or STEM.

So, what's the bottom line? How much is a CubeSat project going to cost? Unfortunately, there isn't a standard price tag we can show you. The amount of funding you're going to need to budget for depends on a number of different factors, the most important of which include the mission's complexity, the experience level of your personnel, the project's duration, and whether you need any specialized hardware (see **FIGURE 9**).

Before you start searching for funding, be sure to research the mission's requirements and create a detailed cost estimate to avoid the pitfalls of being



Students Alex Diaz and Riki Munakata of California Polytechnic State University testing the **LightSail** CubeSat. LightSail is a citizen-funded technology demonstration mission sponsored by the Planetary Society using solar propulsion for CubeSats. [The Planetary Society]

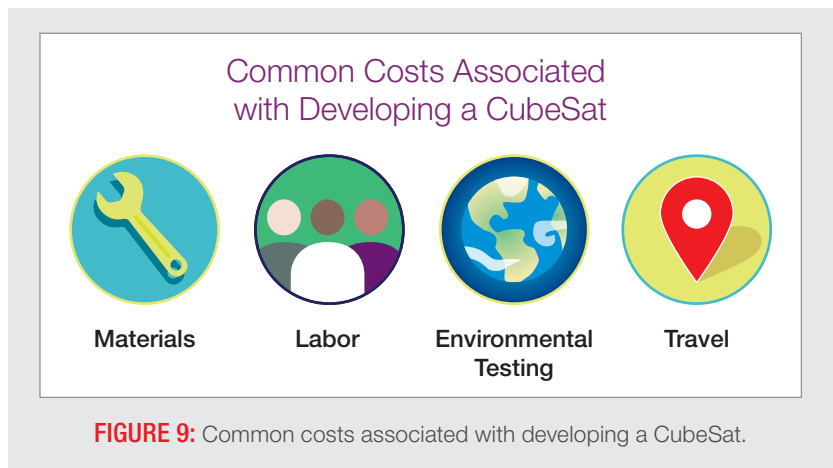

DID YOU KNOW?

Crowdfunding

It's probably crossed your mind already, and yes, crowdfunding is an option. You may not be able to get all of the money you need through crowdfunding, but CubeSat developers have used this method in the past. Just be aware that what makes for a popular crowdfunding idea does not necessarily mean it is a good CSLI idea.

One of the most successful crowdfunded CubeSats is LightSail, developed by The Planetary Society (TPS). Carl Sagan was one of the founding members of TPS, and now the famous science educator Bill Nye holds the reins as CEO. LightSail is their flagship project. It's a 3U CubeSat that is designed to unfurl a 32-square-meter sail, with the intent of propelling itself by sailing on the Sun's radiation. So far, one LightSail CubeSat has been launched as a technology demonstration through CSLI. It's an ambitious project—and according to the Kickstarter Web site, LightSail-2 has raised over \$1.24 million. Your team might not have the media resources that TPS does (meaning you won't get a million dollars), but other teams have acquired more realistic amounts through crowdfunding, so it could be a viable option for your team.

Technology Demonstration Missions

A number of CubeSat missions have been funded by Government agencies or commercial organizations to perform technology demonstrations. For example, say someone at NASA JPL is working on a \$100 million satellite and will include some brand new technology that hasn't been to space yet. To lower the risk to their own very expensive satellite mission, JPL will help someone else to incorporate this new component on a CubeSat platform to take it for an inexpensive test drive. This is an excellent option for newer organizations and universities that want to get experience building CubeSats, but don't have significant resources.

underfunded. To build a cost estimate, start by looking online for component suppliers. That will help you get an idea of the costs of materials. We'll include more details about components in the design chapter ([Chapter 2.4](#)). Funding will also need to cover your ground station (see [Chapter 2.10](#)) and any environmental testing, which can include vibration, thermal vacuum bakeout, shock, and electromagnetic interference/electromagnetic compatibility (EMI/EMC) testing (See [Chapter 6](#) for test descriptions), plus anything else the launch vehicle provider wants to throw at you. When possible, project reserves of at least 10% should be part of the budget to address any unexpected events. One common cost that is often overlooked is the cost for travel. CubeSat developers are typically required to travel to at least one review, and later to deliver the CubeSat for integration



KickSat is a technology demonstration mission designed by Zachary Manchester of Cornell University to demonstrate the deployment and operation of 104 Sprite “ChipSats” developed at the university. KickSat was funded by over 300 individual backers on the crowdfunding Web site Kickstarter. KickSat was launched by NASA's CubeSat Launch Initiative on the ELaNa V mission as an auxiliary payload aboard the SpaceX-3 Cargo Resupply Mission on April 18, 2014. [Cornell University]

into its dispenser. All of these items should be included in your cost estimate. CSLI will only cover the costs of the launch, which include the CubeSat dispenser, the **integration services**, and the launch itself.

2.3 Merit and Feasibility Reviews (1–2 months)

As part of your proposal to CSLI, your team will be required to perform a merit review and a feasibility review. These reviews help assure mission stakeholders (and everyone else involved in the mission, i.e. CSLI, the launch vehicle provider, other sponsors, etc.) that your team or organization is capable of fulfilling your obligations and completing a successful and worthwhile mission. Your team will organize these reviews, and you will choose the reviewers. And to make sure everything is on the up-and-up, the review panel must be made up of individuals who are not on the project team. For the merit review, choose reviewers who have knowledge/experience with your focus area (science, technology and/or education) and that can assess why a flight opportunity is required. For the feasibility review, choose reviewers ideally with knowledge of space flight and spacecraft, but otherwise knowledgeable in various areas of hardware and project development and that can assess your team's ability to deliver your spacecraft on time and on budget. If your focus area includes science or technology, be sure to include someone knowledgeable on that specific area. Keep in mind that you are not just trying to check a box; you want honest, valuable, and useful feedback to your objectives and design, so that you can improve your chances of a successful proposal and successful mission.

The exact details for these reviews will be stated in CSLI's official call for proposals, but a basic synopsis is included here for your reference.

Merit Review

Before submitting your proposal to CSLI, your CubeSat's intended mission must pass an intrinsic merit review. This review will assess the goals and objectives of the mission to determine the quality of its investigation in regard to science, education, and/or technology. It will also determine if the overall investigation supports one or more of the science, education, technology, and/or operations goals or objectives of the NASA Strategic Plan. The more closely your mission aligns with a goal or objective of the NASA Strategic Plan, the more likely it is that your CubeSat will be selected.

integration services: This normally includes, at a minimum, review of your deliverables, the dispenser, integrating your CubeSat into the dispenser, any testing that is done on the dispenser/CubeSat system, and physically integrating the dispenser/CubeSat system onto the launch vehicle.

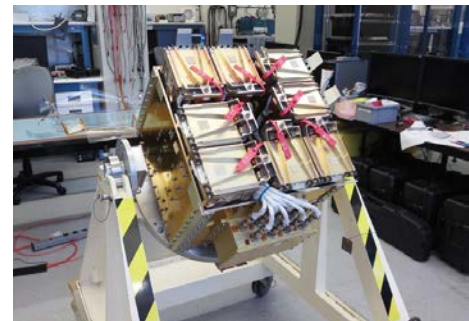

Integration of the NRO's Government Rideshare Advanced Concepts Experiment (GRACE) carrying multiple payloads, which were included as auxiliary payloads aboard NROL-55. GRACE contained 13 CubeSats, including 4 of NASA's CubeSat Launch Initiative CubeSats, as part of the ELaNa XII mission. [Cal Poly]

Feasibility Review

In addition to the merit review, your team must also complete and pass a feasibility review prior to submitting the proposal. This review will judge whether your CubeSat’s mission is achievable with regard to “technical implementation,” including feasibility, resiliency, risk, and the probability of success. Bottom line: Is this mission even possible, and can your team get it done?

➔ **CSLI is not only interested in the outcomes of the merit and feasibility review but also how you addressed any findings from the reviews to resolve any issues or concerns identified by the reviewers.**

2.4 CubeSat Design (1–6 months)

You will probably begin your design process with a lot of research. CubeSats have been around for a while now, and there are plenty of developers who have already made mistakes from which you can learn. Most of these developers are also very open and eager to share their successes and failures with others. There is plenty of material published online that may prove useful to you. We would also recommend attending one of the many annual conferences where you can meet and chat with members of the CubeSat community. A problem that may seem impossible to you might be old hat to someone who’s been working in this field for a while.

You will also need to research which components will work best for your CubeSat system. Luckily for you, CubeSats have become increasingly popular, and the availability of commercial off-the-shelf parts has vastly increased. Although most popular components can now be purchased through commercial vendors, many educational organizations still try to build and design as many components as possible in-house in order to enhance the educational experience, as well as to keep costs low. Because new companies are entering the marketplace every year, we can’t give you a complete list of CubeSat component vendors, but an Internet search will reveal a number of useful suppliers. A list of companies that supply CubeSat components can also be found at <http://www.cubesat.org> on the Developer Resources page. The list on this page is updated regularly, but it isn’t meant to be a complete list of every vendor on the market.

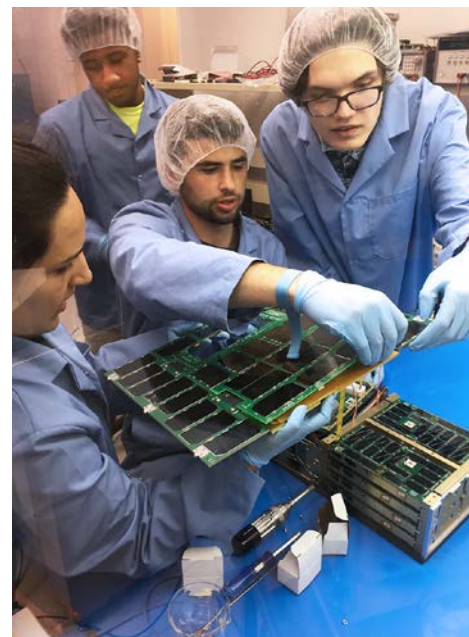

Students Sergei Posnov, David Einhorn, Thompson Cragwell, and Maria Kromis are working on the **ANDESITE** CubeSat from Boston University. ANDESITE will measure small-scale spatial magnetic features in the auroral current systems. The measurements will be made through a constellation of picosatellites deployed by the main payload and will communicate over a mesh network. [Boston University]

> FREE ADVICE

KEEP IT SIMPLE. Keep the design as simple as possible. CDS requirements are on the conservative side. The CDS prohibits pyrotechnics, and discourages a host of other cool stuff. Some violations would be unacceptable, but some may be waived or approved on a mission-by-mission basis. You will, however, be eligible for more launches if you adhere to these specifications. Things like a propulsion system may make the launch provider or their primary payload nervous, and some just choose not to carry CubeSats that have them. So CSLI may still select your CubeSat for launch but it may take longer to find a willing launch provider to give you a ride.

IMPORTANT COMPONENTS SHOULD BE ON THE EXTERIOR. No matter how well you plan and design your CubeSat, it's almost certain that something will break. Usually this happens during environmental testing (i.e., vibration/shock testing). This is normal for a new design, but there are things you can do to make the repair work simpler and quicker. Most of the time, if you need to fix something on the inside of your structure (i.e., remove panels and take things apart), you will be required to perform certain testing again. However, if you design your CubeSat so that important components are near the exterior and easy to access, then the rework may be simple and retest might not be necessary.

DO NOT DESIGN TO THE LIMITS OF THE ENVELOPE. The CDS defines the standard CubeSat “envelope”—that is to say, the length, height, and width dimensions of the CubeSat body—very specifically. It's extremely important that your CubeSat measurements fall within the tolerances set in the CDS. If your CubeSat doesn't fit, it doesn't fly. It's a pretty terrible feeling to deliver your satellite and find out it won't fit in the dispenser, so make sure your design targets the optimal dimension measurement, and the rest will be down to manufacturing. Pay attention to any planned protrusions as well. The CDS allows protrusions from the CubeSat body up to 6.5 mm from the surface. Most deployers can accommodate something a little longer, but that's a dangerous path to walk. Simply put, as long as your CubeSat stays within the dimensional bounds of the CDS, there should be no problem when you deliver it.

DOUBLE UP ON THAT BURN WIRE. You may not know what burn wire is yet, but don't worry, it's a very simple (and pretty reliable) method for constraining deployable components. A lot of CubeSats use deployable solar panels to increase their Sun exposure, and virtually all CubeSats use some form of deployable antenna. Before the CubeSat is released into orbit, these deployables need to be constrained. The most common method to constrain a deployable is to tie a fishing line to its component and route the other end around a simple resistor, also called the burn wire. When it's time to release the deployables, a current is run through the resistor. When the resistor produces enough heat, the fishing line melts and releases the deployable. The only problem with this method is that sometimes the fishing line comes loose during vibration testing or ascent. Launch providers hate that. Use two separate burn wires to give yourself, and the launch providers, some peace of mind. It should reduce the likelihood of a deployable coming loose prematurely during testing.

USE FAMILIAR COMPONENTS. Whenever possible, choose major components that have flown on CubeSats before. Major components include batteries, antennas, and attitude determination and control systems (**ADCS**). You aren't restricted to using components that have flight heritage, but it reduces the risk of failure and gives the launch provider more confidence that your CubeSat won't create problems.

USE UL LISTED BATTERIES. If a battery is “UL listed” it means that the company UL, LLC, has given this battery its stamp of approval, which is recognized industrywide. UL puts batteries through a specific round of testing that shows the batteries are reliable and meet certain industry specifications (i.e., environmental, testing to predetermine levels). Developers across the board prefer to use UL-certified batteries. If you use a battery without the UL certification or try to make your own battery, the launch provider will require you to perform extra testing on your batteries to prove their robustness. The same goes if you tamper with a UL listed battery or its safety features.

USE OF HIGH-MELTING POINT MATERIALS. (See inset in *Chapter 6.1*)

You'll want to get started on your design as soon as possible. Depending on the level of expertise of your team, you will encounter a number of setbacks during development, so it's very prudent to give yourself as much time as possible.

To help you avoid some of those setbacks, we've started a list of design considerations for you to check out. (See Free Advice on the preceding page.) Almost everything on this list is derived from real-world experiences and mishaps that have cost developers valuable time and have given everyone involved extra truckloads of stress.

2.5 Development and Submittal of Proposal in Response to CSLI Call (3–4 months)

We won't get into too much detail about what needs to be in your proposal. The specific proposal instructions for any Announcement of Opportunity (AO) sent out by CSLI are detailed in the official announcement posted at <http://www.fbo.gov> or http://go.nasa.gov/CubeSat_initiative. Timelines may vary, but proposals are usually due within 4 months of the AO being posted. Typically, the AO is posted in early August and the proposals are due in November. Instructions on how to submit the proposal are included in the AO. Typically, CSLI requests that the proposal be e-mailed to a specific NASA representative.

It's extremely important to follow the AO instructions, and to include all of the requested information in your proposal. If the CSLI proposal evaluation team finds that your proposal is not compliant with the AO, or is lacking any of the information required by the AO, then your proposal will be removed from consideration for that selection period. You will need to rework your proposal and resubmit it to a future AO in a subsequent year.

➔ **Remember when writing your proposal to emphasize how your CubeSat mission satisfies all of the points listed in Keys to CSLI Selection in Chapter 2.1.**

When submitting your proposal to CSLI, you will be asked to denote your project's focus area(s): science, technology investigation and/or education. If you choose to select more than one focus area, your proposal and reviews must address the goals and objectives you will be meeting for each focus area. For example, if you choose science and education, your proposal will be reviewed equally for the quality of your science investigation and your education outcomes described in your submission. Using this example, a proposal with a strong science investigation could

ADCS: The ADCS is the system designed to stabilize and orient the CubeSat toward a given direction. This is a critical system for mission success. If the satellite needs to point its solar panels toward the Sun to get the most power possible or if you are taking images of the Earth its attitude has to be set to the correct value.

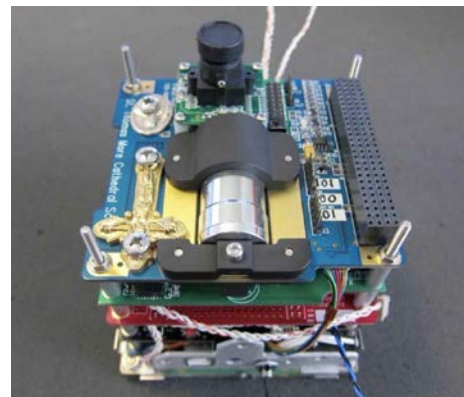

The **St. Thomas More Cathedral School (STM)Sat-1** mission is an education mission to provide hands-on, inquiry-based learning activities with an on-orbit mission to photograph Earth and transmit images. STMSat-1 was the first CubeSat launched for a primary school. It was launched by NASA's CubeSat Launch Initiative on the December 6, 2015 ELaNa IX mission on the fourth Orbital-ATK Cygnus Commercial Resupply Services (CRS) to the Space Station and deployed on May 16, 2016. [St. Thomas More Cathedral School]

receive a substantially lower review if the proposal doesn't contain an equally strong education plan. Therefore, choose wisely and conservatively.

After the CubeSat has been selected it will be manifested on a mission. At that time NASA and the CubeSat developer will enter into a contract with a lot of legal jargon (e.g., liability, risk, data-sharing, etc.). This contract is called a CRADA, which stands for Cooperative Research And Development Agreement. NASA will write up this contract and send it to you, the CubeSat developer. But because there are real legal consequences involved with this contract, you are strongly advised to have a legal expert review it with you. Most CubeSat developers send it to their sponsoring institution's legal department. In the case of university CubeSat projects, the university's legal department typically reviews the agreement.

2.6 Selection and Manifesting (1–36 months)

Once proposals have been submitted, CSLI's Selection Recommendation Committee will determine which proposals meet all of the standards outlined in the AO and will create a prioritized list of the qualifying CubeSat projects.

How do you get your CubeSat to the top of the priority list? First, your merit and feasibility reviews need to look great. Second, make sure your proposal hits all of the points in *Chapter 2.1 Keys to CSLI Selection*. Third, make sure your proposal clearly shows how you contribute to meeting one or more goals/objectives in the NASA Strategic Plan. Your proposal needs to be interesting and—if at all possible—groundbreaking.

Having priority doesn't mean you'll be manifested on the next CSLI launch, because you still need to be matched with a launch that will work for your mission parameters. However, having priority over the other CubeSat teams means you get "dibs" on the first launch that matches your criteria. NASA Launch Services Program (LSP) will pair the selected CubeSats with launch opportunities that are best suited for the CubeSats' missions and completion dates, taking into account the planned orbit and any special constraints the CubeSat's mission may have. Once the CubeSats are paired and manifested, an ELaNa mission number will be assigned.

The prioritized selection list will be released approximately 12 to 16 weeks after the proposal deadline. Prior awards can be viewed at the NASA CSLI Web site.



A set of NanoRacks CubeSats is photographed by an Expedition 38 crew member after the deployment by the Small Satellite Orbital Deployer (SSOD). [NASA]

manifesting: The process of assigning CubeSats to the available slots on a launch opportunity.

2.7 Mission Coordination (9–18 months)

Let's talk about mission coordination. This is another term that's very common in the aerospace industry, but not so much in other fields. When any undertaking involves more than one party, a certain amount of "coordination" is required. CubeSat missions involve, at the very least, a CubeSat developer and an LV provider. The missions that CSLI sponsors will typically include a **mission integrator**, who is responsible for the coordination. A mission integrator is assigned once a launch opportunity is identified and one or more CubeSats are manifested to that opportunity. Note that the term "mission" here is bigger than your CubeSat "mission." The mission now represents your CubeSat plus any other co-manifested CubeSats, the dispensers, the launch, and the deployment. This coordination includes managing integration schedules, deliverable documentation, and how the requirements will be verified. In other words: mission coordination is a catchall term for the overall mission planning and the submitting and keeping track of paperwork that will be required to pass between the LV provider and the CubeSat developer. The mission integrator will be responsible for the schedule and communication between the parties to make sure all CubeSat requirements are verified on time.

Mission coordination will begin about 18 months before the scheduled launch date. It will start with a "kickoff" meeting between all of the developers on the mission and the mission integrator. Don't worry, you shouldn't need to travel anywhere for this; the kickoff will be conducted over the phone as a teleconference (also called a "telecon"). The CubeSat developers aren't expected to know all of the ins and outs of the requirement verification process, so the mission integrator will help guide the developers through the process. The mission integrator will supply the developer with a schedule for hardware and document **deliverables**, and document templates for each document deliverable. The mission integrator is also responsible for creating a mission-specific CubeSat-to-dispenser Interface Control Document (ICD)—check out the ICD in [Chapter 4.1](#) for more details. This ICD is, essentially, the official rulebook for your CubeSat. You and the mission integrator will work together to show that your CubeSat meets every one of the requirements stated in the ICD. These requirements are derived from the CDS and the launch vehicle's specific needs. The ICD will also specify the relevant environmental testing levels and durations to which your CubeSat will need to be tested. To help keep everyone on track, the mission integrator will organize regular telecons to discuss the current status of the mission, get CubeSat development updates, and provide technical assistance and guidance.

mission integrator: You may be asking yourself why the mission *integrator* isn't called the mission *coordinator*. Well, sometimes they are. The terms "integration" and "coordination" when referring to a mission are commonly used interchangeably. For the purposes of this document, the person/organization responsible for the coordination will be referred to as "mission integrator," and we'll use "mission coordination" to refer to mission coordination *activities*.

deliverables: A deliverable is anything that your team has agreed to submit to the mission integrator as part of your legal obligations under the CRADA. These deliverables will be used to verify that your CubeSat meets the requirements set in the mission ICD. [Chapter 6](#) describes the deliverables required on a typical CubeSat mission.

During this mission coordination phase, your team will be working on hardware fabrication and design, testing, and the documentation you will be submitting to the mission integrator.

2.8 Regulatory Licensing (4–6 months)

We'll go into much more detail about regulation-related licensing in *Chapter 5*, but we'll explain the basics here. All CubeSats must go through a licensing process in order to transmit radio signals and a separate process to license the use of an imaging instrument such as a camera. **Obtaining licenses for satellites can be a lengthy process. Prior to finalizing any system design and operations plan and before submitting any application, you should understand regulatory constraints and clearly identify all necessary information required for licensing. Once all the necessary information is documented, you should submit your application, as soon as possible**, preferably within 30 days after your CubeSat gets manifested or earlier. If you don't have all of the necessary licenses in hand prior to your CubeSat's final delivery date to the integrator, you risk your CubeSat being demanifested from the mission. This means you will be bumped from the launch. Don't let that scare you too much; as long as you comply with regulatory rules, prepare a complete application, and get your paperwork started early, as recommended here, there should be time to get your license granted.

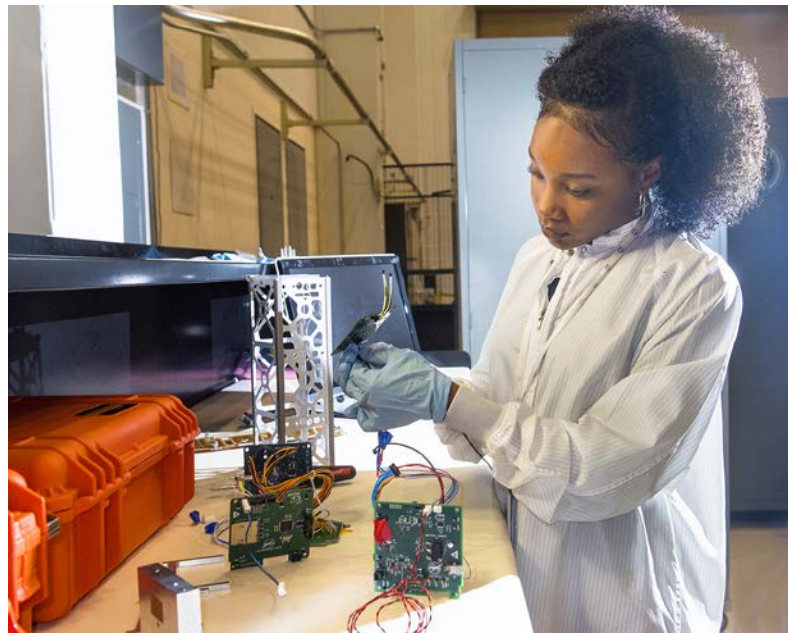

More than likely, you will need to obtain a radio license because your CubeSat, like most other satellites, probably needs to transmit on a radio frequency (RF) to communicate with the ground and Federal law requires a radio license for that. Licenses to transmit RF to or from U.S. Government operated satellites are handled by the National Telecommunications and Information Administration (NTIA), while the Federal Communications Commission (FCC) handles all other non-Federal Government agency operated satellites. Before you get started, see *Chapter 5* to help you determine which agency, and which license, is appropriate for your CubeSat and its mission.

Naia Butler-Craig, a systems engineer intern at NASA's Glenn Research Center, works on assembling and testing the **Advanced Electrical Bus (ALBus)** CubeSat. The ALBus CubeSat is a pathfinder technology demonstration for high power density CubeSats. [NASA/Bridget Caswell, Alcyon Technical Services]

The second license you may have to obtain is based on whether your CubeSat includes an imager, or camera. Anyone who intends to operate a non–Government owned U.S. CubeSat with an imager must contact the National Oceanic and Atmospheric Administration (NOAA) to find out whether a remote sensing license is necessary, and if it is, to get the application process started. This process can be lengthy, and the FCC will need to see your license from NOAA before it will finish processing your RF license. Many more details on obtaining a NOAA license can be found in Licensing Procedures ([Chapter 5](#)).

WARNING!

Being demanifested for a licensing issue sounds scary, and it is. The regulatory agencies take this very seriously. There was a CubeSat on an early CSLI launch that had been integrated into the dispenser, and onto the launch vehicle, without an approved FCC RF license. CSLI and the integrator had assumed it would be granted before launch, but a few days before launch this still hadn't occurred. There wasn't time to remove the CubeSat from the dispenser, so the integrator was planning to go to the launch vehicle and disable the release mechanism, so that the CubeSat could not be released into orbit. Luckily for the CubeSat developer, the license came through just before it was too late. Otherwise, **not only would their mission have been scrubbed, but they also would have lost their CubeSat!**

2.9 Flight-Specific Documentation Development and Submittal (10–12 months)

Once your CubeSat is manifested on a launch, the mission integrator will provide a list of deliverables (documents that CSLI and the mission integrator need from your team) that will need to be completed and submitted by a specified date. These documents will be used to verify that your CubeSat meets all safety and launch requirements set by the ICD. The first of these documents will likely be due shortly after your first kickoff meeting with the mission integrator. These deliverable documents will be discussed in more detail in the Flight Certification Documentation section ([Chapter 6](#)) of this document.

2.10 Ground Station Design, Development, and Testing (2–12 months)

You will need a way to communicate with your CubeSat once it's in space. For that you need a ground station. There are a lot of components required for a proper ground station, but two basic components you will need are a radio and an antenna. Your ground station should be built early in your project's timeline. If your team isn't experienced with CubeSat communications and the hardware required, building and testing your ground station will consume a lot of time and energy. Most teams prefer to use off-the-shelf amateur radio components, and there are typically local amateur radio club members willing (excited, even) to advise and help with building and commissioning the ground station. You can find these types of groups online (i.e. American Radio Relay League <http://www.arrl.org/>). Some good basic design information also can be found on <http://www.cubesat.org>.

Thorough testing of the ground station is critical for your mission's success. The ground station is used to locate the satellite as well as to send commands and to downlink data. Launching with an inadequate ground station is a mission killer. Your ground station should be tested early and often. By monitoring existing satellites, your team can gain experience operating the equipment. This experience is invaluable in the satellite building process, particularly when writing the software and command structure. Additionally, it's important to have your ground station in the loop during development. There are many satellites (CubeSats, amateur satellites, NOAA satellites, Space Station, etc.), which can be tracked, and even commanded if you coordinate with the satellite's operators. Participating in such

> FREE ADVICE

TROUBLESHOOTING BASICS. The ground station has many components operating independently, any of which, if not working properly, can cause communication issues. When troubleshooting, take a systematic approach. Make sure antennas are pointing where expected by using calibration points like mountains, the Sun, or the Moon for azimuth and elevation. Use a vector network analyzer, if available, to check the impedance of the antenna, cables, and any adapters in the path to the radio. Also confirm that the radio is tuning to the expected frequency, is in the right mode, and that line levels are appropriately set between the radio and the **terminal node controller (TNC)**/ computer. Software defined radios, particularly the small, less expensive options like the RTL2832 or FunCube, are an excellent way to capture and replay slices of RF spectrum for later decoding practice.



Anthony Young works in the ground station at Santa Clara University, Santa Clara, Calif., in support of NASA's **Organism/Organic Exposure to Orbital Stresses (O/OREOS)** CubeSat. [NASA]

terminal node controller (TNC): The TNC is a device used by amateur radio operators to participate in AX.25 packet radio networks. It will assemble the data into packets of information and key the transmitter to send the packets of data to the ground station. Once the ground station receives the packets, the packets are reassembled and encoded to a form that can be interpreted by your ground station.

activities can be valuable experience for your CubeSat team. (See [Chapter 2.16](#) for more on tracking satellites).

Your team should become familiar with commonly tracked satellites and their operating modes and frequencies. In the 437 MHz (70 cm) band there are plenty of CubeSats with beacons strong enough to easily receive, but it is necessary to know which ones are active and which are not. As a rule of thumb, look for recently launched CubeSats, as those are most likely to be operating. Contact the organization that developed (and is most likely operating) the CubeSat, if necessary, to confirm operation. In the 140 MHz (2 m) band, the NOAA weather satellites are an excellent test object and produce interesting images.

On your launch day, you'll want to be as knowledgeable about CubeSat communications (CubeSat comms) and satellite tracking as humanly possible, so do as much research as you can. This includes contacting experienced university CubeSat programs, reading papers and presentations online, and going to small satellite conferences to chat with your fellow developers. With all of the resources available to you, you shouldn't have too much trouble getting your team up to speed before launch.

2.11 CubeSat Hardware Fabrication and Testing (2–12 months)

As mentioned in the CubeSat Design section ([Chapter 2.4](#)), many hardware components may be purchased from commercial vendors, but fabricating in-house whenever possible can help keep costs down and, for educational CubeSat projects, can increase learning opportunities. The timeframe for this part of the process varies greatly depending on how ambitious the design is and how experienced your team is. Be conservative in planning and pad your build schedule with plenty of **margin**.

Keep in mind that it's cheaper to build two satellites at once than to build one and later decide to build another. Launch opportunities are very fluid, and launch failures are always possible. If financially possible, it is extremely useful to build multiple units (e.g., one **Engineering Test Unit—known as an ETU**, a **FlatSat**, and two flight units). Qualification testing and integrated development can be performed on the ETU, troubleshooting on the FlatSat, and final environmental testing can be done on the flight units. No two satellites are exactly the same, so building two flight units gives the option to fly the best hardware.

margin: This is a very common term in the engineering world specifically referring to the safety margin, but is more generally used to refer to extra anything that gives you peace of mind. When you're talking about scheduling, you add time, or margin, in case you run into issues or just estimate incorrectly.

ETU: An engineering test unit. An ETU is built like the flight unit, but is not intended for launch. Developers will typically use the ETU like a practice dummy. It can be used to practice putting the components together, fit checks, hardware and software testing, and anything else that you don't want to try for the first time on your valuable flight unit.

FlatSat: A FlatSat is exactly what it sounds like. It's an engineering unit of the CubeSat that includes all of the components, except the structure. Typically, the components are mounted on some sort of flat board, hence the term FlatSat. Developers can use the FlatSat to test and troubleshoot the CubeSat's systems without integrating everything onto the structure.

During assembly of the flight satellites, developers are encouraged to take as many pictures as possible at regular intervals. Keeping detailed photo documentation during all phases of assembly, integration, and testing has saved some flight missions in the past. We can't stress enough how important it is to keep good, detailed records of your successes and failures as you progress. One of the most common problems CubeSat teams have had is losing knowledge and expertise when team members move on and are replaced by new personnel. University CubeSat developers have the greatest problem with senior members graduating before the completion of the project.

> FREE ADVICE

KEEP EXCELLENT RECORDS OF EVERYTHING YOU DO. It is incredibly important to keep great records of the work your team has been doing. These records should be in the form of photographic evidence and thorough documentation. This is especially important for student organizations that will be losing senior team members as they graduate. Keeping records helps continuity within the project; you'll avoid "reinventing the wheel" over and over again.

There are two types of testing you will do for your CubeSat. The first type, development testing, is internal testing you'll do for your own purposes. The second type, verification testing, you'll do to prove to CSLI and the launch provider that your CubeSat is safe and sturdy. You can do as much development testing as you want, and no documentation will be due to CSLI. Once your CubeSat build is complete, you will be required to perform specific testing and submit test plans and reports to verify that the CubeSat meets the ICD requirements. After verification testing is performed, you cannot work on the CubeSat any longer, or you will be required to perform the verification testing again. Verification testing typically includes vibration and thermal vacuum tests, and in some cases shock, EMI/EMC, and static load tests, to ICD-prescribed levels. Day In The Life (DITL) testing is also required to show that **electrical inhibits** and timers will function correctly.

For vibration and shock testing, testing containers may be available for your CubeSat. This testing container is a simplified version of the actual flight dispenser to act as a flight-like interface between your CubeSat and the testing apparatus. Ask your mission integrator if there are testing versions of your assigned dispenser available.

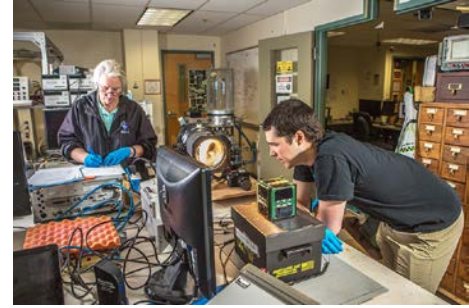

Denise Thorsen and Jesse Frey from the University of Alaska Fairbanks are performing DITL testing on the **Alaska Research Center (ARC)** CubeSat. ARC was launched by NASA's CubeSat Launch Initiative on the ELaNax XII mission as an auxiliary payload aboard the NROL-55 Mission on October 8, 2015. [University of Alaska, Fairbanks]

electrical inhibit: An electrical inhibit is a physical device that interrupts the "power path" needed to turn on your CubeSat and/or other potentially hazardous devices.

> FREE ADVICE

DEVELOPMENT TESTING. “Test like you fly” is a common mantra for CubeSat developers and applies to more than just final environmental testing. During electronic development, use evaluation and development kits and **breadboard** components before fabricating boards. Once the printed circuit boards (PCBs) are produced, test as many expected functions as possible before interfacing it with other systems. Keep the scope small with testing and add components systematically, testing them along the way. Never assume that boards or subsystems that work well during standalone testing will work well when integrated with other boards or subsystems.

During mechanical development, it is useful to do thermal and vibration tests on individual subsystems prior to integrating all components. This often catches design issues early on and reduces over-test on the overall system.

breadboard: A breadboard is a board used to make an experimental model of components for testing.

Testing should be completed with all documentation submitted to the mission integrator no later than 1 month prior to the readiness reviews.

2.12 Mission Readiness Reviews (Half-Day)

The Mission Readiness Review (MRR) is a presentation that you will deliver to CSLI and the mission integrator summarizing all of the evidence you’ve provided to show that your CubeSat satisfies all of the requirements in the ICD. All of your deliverable documentation should be submitted to, and accepted by, the mission integrator prior to this review. That means all testing should also have been completed, and your CubeSat should be completely finished. This review cannot be completed by telephone; all CubeSat teams manifested on the mission are required to send at least one representative to present at the readiness review—so don’t forget to budget for travel! The location of the review will be determined by LSP and the mission integrator. An MRR outline or template will be provided to each team by the mission integrator at least 1 month prior to the review. Your team will be required to submit a draft of the presentation 2 weeks or more before the review. This MRR pre-check of your draft is for your benefit as well as the reviewers. The mission integrator will be able to catch a lot of errors and ensure all information is covered so the actual MRR goes as smoothly as possible.

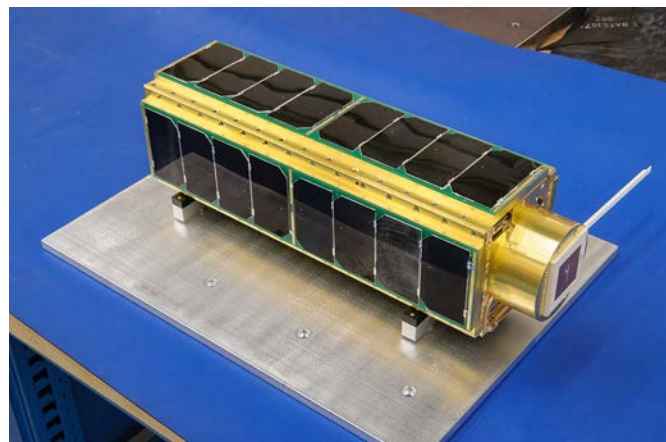

SporeSat undergoing vibration testing. SporeSat is a space biology science mission designed by Ames Research Center to gain a deeper knowledge of the mechanism and determine the threshold of cell gravity sensing. Launched by NASA’s CubeSat Launch Initiative on the ELaNa V mission as an auxiliary payload aboard the SpaceX-3 Cargo Resupply Mission on April 18, 2014. [NASA Ames Research Center]

2.13 CubeSat-to-Dispenser Integration and Testing (2 days)

It's delivery day! You've completely finished your CubeSat—all testing is complete and all paperwork has been submitted. Now you get to deliver your CubeSat to the integration site, the location of which is determined by the mission integrator. When you arrive at the integration site you'll unpack your CubeSat and move it into the integrator's clean room. It's not required, but the integrator may request that you help with the integration process. This means being responsible for positioning the CubeSat on the workbench while the integrator takes the pre-integration physical measurements. Some integrators will make a great effort to avoid handling the CubeSat. You may even get to insert your CubeSat into the dispenser. In addition to integration activities, and assuming the integration facility allows cameras, there may be photo opportunities. These photos can be great publicity for your program—and for your scrapbook—so don't forget to bring your pretty smiles! Once the dispenser door is closed, and all photos are taken, your job is done. The integrator will seal the dispenser and that typically concludes day 1.

On day 2, the dispenser and CubeSat will go through a final vibration test as a single unit to make sure integration was successful. And that's it—the integrator will take it from there.

Generally, the developers are required to attend integration. This is to ensure that if any issues arise they can be addressed real time and it is also the last time you'll see your CubeSat.

After integration to the dispenser is complete, you won't have access to the CubeSat again. With prior approval, you may run system diagnostics or perform battery charging at the integration site before the CubeSat is buttoned up in the dispenser. However, in the event that there is a very long launch delay (e.g., if your launch is delayed by several months) the developers may have an opportunity to access their CubeSats again, but this is only in extreme circumstances and is by no means guaranteed.

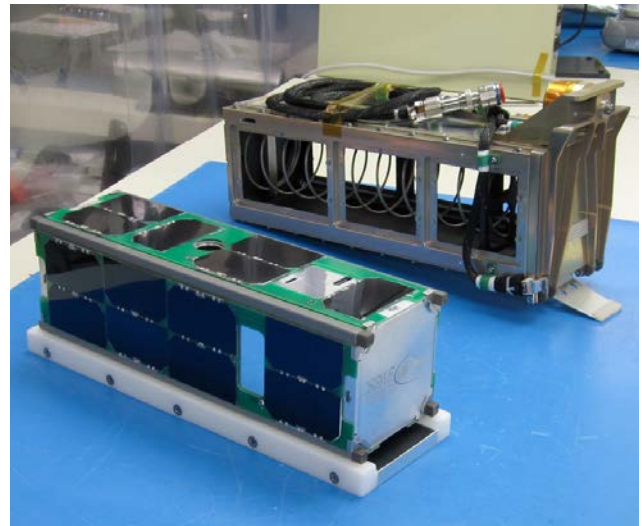

The **CSSWE (Colorado Student Space Weather Experiment)**

CubeSat and PPOD just prior to integration. The CSSWE launched on September 13, 2012 as an auxiliary payload on the ELaNa VI mission aboard the NROL-36. [University of Colorado at Boulder]

Any special accommodations (clean room, temperature, humidity, security, storage, etc.) that your CubeSat requires at the integration site should be requested at the start of the mission. Additionally, you will need to inform the integrators about any Ground Support Equipment (GSE) you plan to bring to the site, as well as any potential hazards to integration personnel. If the CubeSat has any possible hazards (e.g., laser emitters), the CubeSat team will need to provide safety gear for the integration team (e.g., protective eyewear).



After the CubeSat is integrated into the dispenser, the mission integrator will inspect the loaded dispenser one more time. Then the dispenser will be packaged and shipped to the integration site where the loaded dispenser will be integrated onto the launch vehicle.

Technicians integrating a PPOD containing CubeSats onto the Delta II launch vehicle as part of the ELaNa X mission that was launched as an auxiliary payload on NASA's Soil Moisture Active Passive (SMAP) Mission. [NASA]

2.14 Dispenser-to-Launch Vehicle Integration (1 day)

Dispenser-to-launch vehicle integration is the point at which the dispenser loaded with your CubeSat is attached to the rocket. This sounds pretty cool, and it is, but unfortunately, you aren't invited. The launch vehicle providers are very protective of their rockets, so only essential personnel are permitted to participate. Essential personnel usually include LSP representatives, the mission integrator, and the launch provider's technicians.

The process only takes about a half-day to a day, depending on the launch vehicle. Not all missions are run the same way, but typically on the big day, the mission integrator will arrive at the launch vehicle site with the loaded dispenser. The LV technicians will lead the integrator to the location on the LV where the dispenser is to be affixed. After a final cleaning and inspection, the mission integrator will hand off the dispenser to the LV technicians. The technicians will follow a prescribed procedure to carefully attach the dispenser to the LV. Finally, photographs will be taken as evidence that the integration was successful, and your CubeSat will be that much closer to space.

The integration to the LV typically occurs 2 weeks to 4 months prior to launch. It all depends on which LV your CubeSat is using. Each mission model is different and explained in more detail in the Mission Models section (*Chapter 3*) of this document.

2.15 Launch (1 day)

The launch location will depend on the primary mission, and will be known well before the CubeSats are manifested. The launch date may change from the original timeline, but only the primary mission or launch vehicle can move the launch date. The CubeSats do not have any influence on the launch or launch window. If your project gets delayed for any reason, the launch will not be delayed. If your CubeSat is not delivered in time, the LV will definitely leave without your CubeSat onboard.

While the CubeSat developers won't have an active role in launch operations, you will usually be invited to come to the launch site and watch the LV take off. Travel will be at your own expense, but most teams think it's well worth it. While you're there, LSP may ask that you participate in some public affairs and outreach events (e.g., NASA EDGE interviews, photos, etc.).

Be aware that the launch date is subject to change at any time and day-of-launch scrubs are common due to weather and other factors. So, if you plan to travel to the launch, it may be wise to include some extra days in the event of a last-minute launch delay.



Launch of ELaNa-II from Vandenberg Air Force Base, CA on December 6, 2013. Four CubeSat Missions were deployed. [Corkery/ULA]

2.16 Mission Operations (variable, up to 20 years)

Initial operations can be the most exciting part of a satellite mission, especially to first-time flyers; however, it can also be the most challenging. But not to worry, the mission integrator will work with your team to get communications up and running after launch.

By now your team should have had plenty of practice using the ground station on engineering and/or flight versions of your own CubeSat, as well as some practice tracking existing CubeSats. You may have even been able to request permission from other CubeSat teams to uplink to their satellites. Having operations experience during the development of your CubeSat is invaluable because it helps you decide what commands will work best when your CubeSat is in orbit. Existing satellites are a good starting point because the orbit and satellite behavior should be well established.

> FREE ADVICE

HOW TO TRACK A SATELLITE. To predict where any satellite is in orbit, **two-line element (TLE)** sets are entered into satellite tracking software that calculates the expected position of the satellite. TLEs can be generated from various sources; however, the most widely available and accurate TLEs are produced by the United States Air Force's Joint Space Operations Center (JSpOC) at Vandenberg Air Force Base in California. The JSpOC publishes TLEs for most of the satellites currently in orbit on its Web site, <http://www.space-track.org>. The JSpOC Web site is also a great place to review satellite-tracking data, because their records go back to 1957, the beginning of the space program.

two-line element (TLE): A TLE is a data format encoding a list of orbital elements of an Earth-orbiting CubeSat for a given point in time, the epoch. Using a prediction formula, a TLE can be used to estimate the position and velocity in the past, present or future for your CubeSat.

```
0 CXBN-2
1 42704U 98067LM 17304.55488591 .00021073 00000-0 25707-3 0 9994
2 42704 51.6386 74.8642 0001580 42.1764 317.9350 15.60423680 26110
```

Directly following a launch, the first challenge is determining which new object is your satellite. The launch provider usually provides preliminary state vectors before the launch date so the CubeSat developers can plan and schedule their operations. State Vectors specify the position and velocity of CubeSat relative to the Earth's center of mass and are used to predict viewing times and the position of your CubeSat.



The University of Colorado at Boulder **Miniature X-ray Solar Spectrometer (MinXSS)** CubeSat followed by the University of Michigan **CADRE** CubeSat, are deployed from the Space Station on May 16, 2016 on the ELaNu IX mission. The MinXSS mission is a science investigation to study solar flares, active regions, the quiescent Sun, and their impact on Earth's upper atmosphere. The **CADRE** mission is a space weather investigation that will improve our understanding of the dynamics of the upper layers of our atmosphere: the thermosphere and ionosphere. [NASA]

Right after the CubeSats are ejected into orbit on launch day, the launch provider will provide actual state vectors that can be converted into TLEs. It can take some time—from a couple days up to a week or so—for the JSpOC to produce rough TLEs. The accuracy of the TLEs will become more refined over the following few weeks. During this time, the mission integrator will be working both with the JSpOC and the CubeSat teams to help determine which satellite belongs to which TLE. Some CubeSats carry GPS receivers, which helps identify each satellite by process of elimination. It's not uncommon for it to take several weeks to confidently identify all of the satellites from a launch.

If you're planning to use a radio frequency in the amateur band (more frequency band details in [Chapter 5.1](#)), you can get help contacting your satellite from the amateur radio community. In the past, CubeSat developers have posted announcements online to get help from volunteer satellite trackers. These volunteers have been very helpful identifying CubeSats. You can get more details by reaching out to fellow CubeSat teams online and at conferences.

One more resource to help you out is the CubeSat Internet Relay Chat (IRC) channel. During and directly following launch, most of the active amateur satellite-tracking enthusiasts meet on the CubeSat IRC channel to share observations and work to identify each CubeSat. Most "first contacts" occur on this IRC channel, and many are from other parts of the world. To join the CubeSat IRC channel, point your favorite IRC client to: [#cubesat](irc:freenode.net)

3 Mission Models

We know from *Chapter 1* that CSLI has flown CubeSats on a number of different launch vehicles, but did you know that those launch vehicles were sponsored by different organizations? In this chapter we want to tell you about the different types of missions that CSLI CubeSats have been a part of. These organizations have a particular way they like to run their missions. These are called “mission models.” That means your CubeSat team will work with requirements and organization structures specific to the type of mission your CubeSat is manifested on. To better prepare your team for what you can expect, we’ll go over the major differences in the mission models (listed below) that CSLI has worked with thus far.

1. NASA-Procured Launch Vehicle Mission Model
2. Operationally Responsive Space (ORS) Rideshare Mission Model
3. National Reconnaissance Office (NRO) Rideshare Mission Model
4. Commercial Launch Service through a Third-Party Broker Mission Model
5. International Space Station (ISS) Deployment Mission Model

IN THIS CHAPTER

- 3.1 NASA-Procured Launch Vehicle Mission Model
- 3.2 Operationally Responsive Space (ORS) Rideshare Mission Model
- 3.3 National Reconnaissance Office (NRO) Rideshare Mission Model
- 3.4 Commercial Launch Service Through a Third-Party Broker Mission Model
- 3.5 International Space Station (ISS) Deployment Mission Model

Pictured above:

IceCube Team working at NASA’s Goddard Space Flight Center. The objective of the IceCube mission is to demonstrate the technology of a sub-millimeter-wave radiometer for future cloud ice sensing. This technology will enable cloud ice measurements to be taken in the intermediate altitudes (5 km–15 km), where no measurements currently exist. Launched by NASA’s CubeSat Launch Initiative on the May 24, 2017 ELaNa XVII mission on the seventh Orbital-ATK Cygnus Commercial Resupply Services (OA-7) to the Space Station. [NASA]

3.1 NASA-Procured Launch Vehicle Mission Model

It's no surprise that CSLI has placed CubeSats on launch vehicles being used for NASA missions. This is known as the NASA-Procured Launch Vehicle mission model. Every year, NASA LSP procures launch vehicles for NASA and other civil U.S. Government agencies that will conduct missions to further scientific research or conduct technology demonstrations. When those missions' requirements allow for it, CSLI CubeSats are allowed to hitch a ride to orbit. The CubeSat requirements for these flights are based on LSP-REQ-317.01 and the CubeSat Design Specification (CDS), both of which are discussed in the Requirement Sources section (*Chapter 4*).

The organizational chart in **FIGURE 10** outlines the organizations involved in NASA-Procured Launch Vehicle mission model. For CubeSat missions, NASA typically contracts mission coordination duties to an outside organization. Mission coordination duties can include the following: coordinating safety documentation with **range safety**, interfacing with the CubeSat developers, verifying ICD requirements, acting as the point of contact for the FCC and NOAA, performing CubeSat-to-dispenser integration and testing, and coordinating with the JSpOC to identify each CubeSat in orbit. Finally—and here's the part that

range safety: Range safety is the person designed to protect people and assets on both the rocket launch range and downrange in cases when a launch vehicle might expose them to danger.

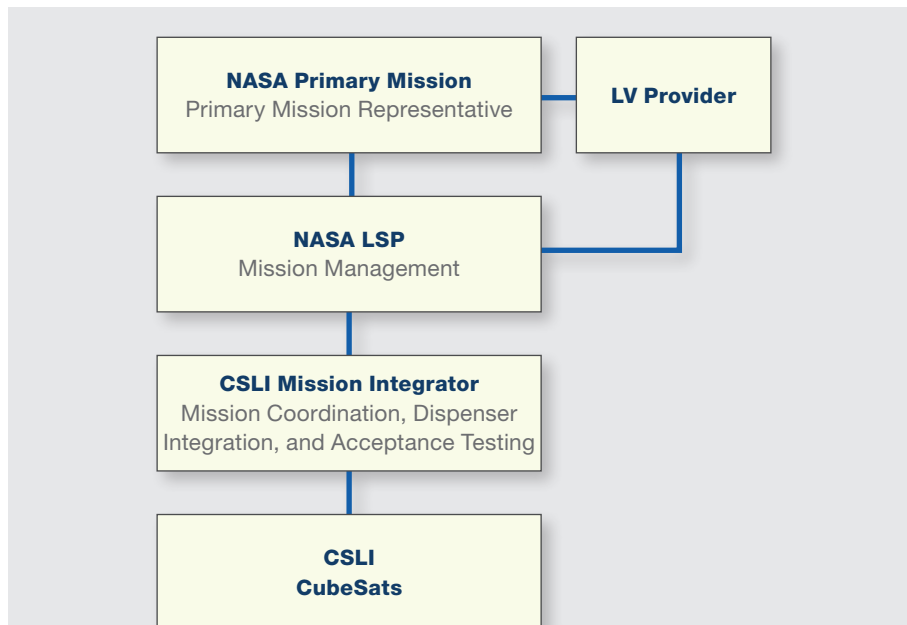

FIGURE 10: NASA-Procured Launch Vehicle Mission Model Organizational Chart



Launch of the ELaNa-X mission on January 31, 2015, as an auxiliary payload on NASA's Soil Moisture Active Passive (SMAP) mission from Vandenberg Air Force Base, Calif. Three CSLI CubeSats were deployed: **FIREBIRD II A,B** from Montana State University, Bozeman, Mont.; **GRIFEX** from the Jet Propulsion Laboratory, Pasadena, Calif.; and **EXOCUBE** from Cal Poly, San Louis Obispo, Calif. [NASA]



A Minotaur I rocket carrying, among other payloads, 11 small CubeSat research satellites as part of NASA's fourth ELaNa mission, lifts off from Virginia's Mid-Atlantic Regional Spaceport Pad 0B at NASA's Wallops Flight Facility at 8:15 p.m. EST Nov. 19, 2013. This launch marked the launch of the first high-school-built cubesat, **TJ3Sat** built by Thomas Jefferson High School, Alexandria, VA. [NASA/Ali Stancil]

affects your team—the mission integrator and/or NASA typically requires regular mission tag-ups via telephone with the CubeSat developers. During these tag-ups the mission integrator will update the team on mission status and ask each developer to provide an update on their CubeSat status. You, as the developer, are expected to keep the mission integrator and NASA informed of your development status and any issues that might crop up.

All of your deliverables will be submitted to and reviewed by the mission integrator and approved by NASA LSP. The mission integrator is responsible for recommending to NASA LSP whether or not each CubeSat team is ready for flight.

NASA will be responsible for ensuring that all CSLI CubeSats comply with NASA orbital debris mitigation requirements and will generate the Orbital Debris Assessment Report (see [Chapter 6.1](#)) for all CSLI CubeSats.

In addition to the documentation, NASA also requires each team to present a readiness review in person to the mission integrator with NASA LSP as an advisor. This is the same readiness review we discussed in the Development Process Overview section ([Chapter 2.12](#)).

3.2 Operationally Responsive Space (ORS) Rideshare Mission Model

The Operational Responsive Space (ORS) Office isn't as well known as NASA, but they've been very supportive of CubeSat missions. It's a joint effort of multiple agencies within the U.S. Department of Defense (DOD), and they have provided space on their launch vehicles to CubeSats in need of a ride to orbit. ORS launches have given rides to CSLI CubeSats as well as to other non-CSLI sponsored CubeSats.

The organizational chart in **FIGURE 11** outlines the ORS Rideshare Mission Model. ORS will contract with a mission integrator to oversee the development and integration of the LV and payloads on the mission. As with the NASA mission model, these responsibilities may include coordinating safety documentation with range safety, interfacing with the CubeSat developers, verifying ICD requirements, acting as point of contact for the secondary missions with the FCC and NOAA, coordinating with the JSpOC for pre- and post-launch identification of objects, and managing the physical CubeSat-to-dispenser integration.

In addition to the ORS mission integrator, there typically will be another mission integrator contracted by ORS to deal specifically with the CSLI CubeSat teams.

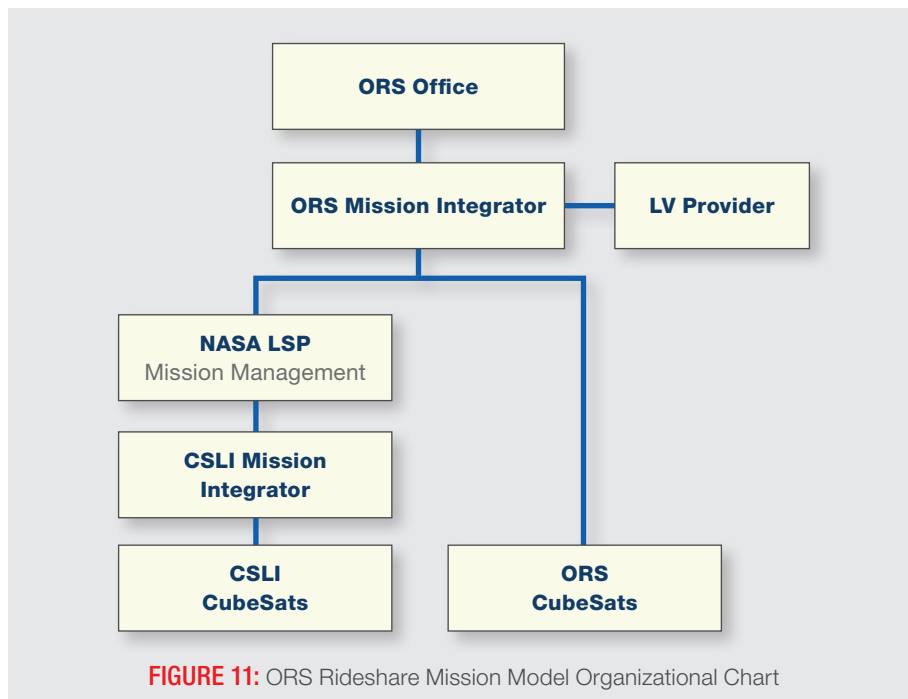

FIGURE 11: ORS Rideshare Mission Model Organizational Chart



The CSLI mission integrator will have scaled-back responsibilities compared to the equivalent role in the NASA-owned mission model, because the ORS mission integrator is responsible for a number of the tasks. The CSLI mission integrator will be limited to tasks related to tracking CubeSat development, performing ICD verification tasks, and providing relevant updates to the ORS mission integrator. This person will also participate in the ORS Mission tag-up meetings with ORS, and will speak on behalf of the CubeSat teams. The CSLI mission integrator will hold separate tag-ups for the CSLI CubeSats. Each CubeSat team will present a readiness review to the CSLI mission integrator and the ORS mission integrator with NASA LSP acting as an advisor. As with all mission models, CSLI CubeSat teams will be required to present in-person for their readiness review.

You, as the CubeSat developer will submit all of your document deliverables to the CSLI mission integrator. So, from your point of view, everything is pretty much the same on an ORS mission as it is on a NASA mission: a member of your CubeSat team will have regular tag-up meetings with a mission integrator, submit all required documentation to an integrator, and participate in a readiness review for final launch approval.

NASA will be responsible for ensuring that all CSLI CubeSats comply with NASA orbital debris mitigation requirements and will generate the Orbital Debris Assessment Report (see [Chapter 6.1](#)) for all CSLI CubeSats.

3.3 National Reconnaissance Office (NRO) Rideshare Mission Model

The NRO has been a great supporter of CubeSat technologies and has flown a number of CubeSats as auxiliary payloads on their launch vehicles. CSLI has worked with the NRO for many years, and if your CubeSat mission is selected by CSLI to fly on a NRO mission, you will work primarily with the Auxiliary Payload Integration Contractor (APIC) team, which can be made up of multiple organizations and is contracted by the NRO.

The chart in [FIGURE 12](#) shows all of the organizations involved in preparing CubeSats for flight on NRO-sponsored launches. The Office of Space Launch (OSL), located at the top of the chart, is the organization within the NRO that deals with launching satellites, as opposed to designing or operating them.



Kathryn Clements and Mary Distler, students at St. Louis University, with the **Argus** CubeSat after completing pre-integration checkout. Launched by NASA's CubeSat Launch Initiative on the ELaNu VII mission as an auxiliary payload aboard the U.S. Air Force-led Operationally Responsive Space (ORS-4) Mission on November 3, 2015. [St. Louis University]

DID YOU KNOW?

The NRO

The National Reconnaissance Office (NRO) is an agency within the United States intelligence community. The NRO is responsible for designing, building, and operating the reconnaissance satellites for the United States Government. Although the NRO was established in 1961, its existence wasn't declassified until 1992. If you'd like to know more about what the NRO does, their Web site, <http://www.nro.gov>, is a great place to start.

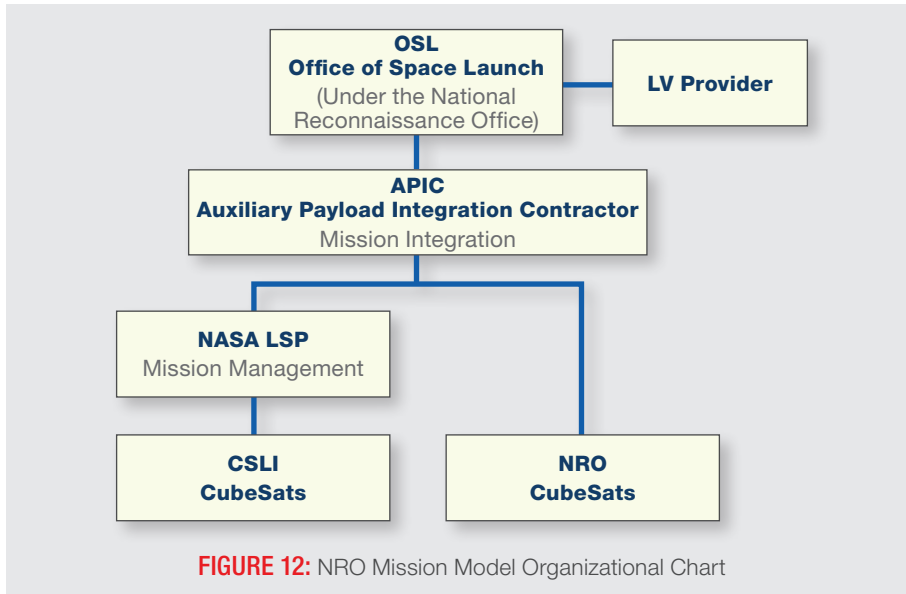

FIGURE 12: NRO Mission Model Organizational Chart

The APIC will be responsible for the mission integrator’s duties and will report regularly to the launch vehicle provider and OSL. For these reports and any readiness reviews to OSL, the APIC will need information and reports from the CubeSat teams; however, the CubeSat teams won’t need to participate in any of these meetings. Instead, the CubeSat teams will meet with the APIC team separately, typically in biweekly tag-ups via teleconference. At these tag-ups, the teams will provide status updates and alert the APIC to any issues that may affect the schedule or their ability to meet requirements.

CubeSat teams will also be responsible for presenting a readiness review to the APIC, just like the other mission models. CSLI CubeSats will be required to present the review in-person to the APIC team, NASA LSP, and OSL.

NASA will be responsible for ensuring that all CSLI CubeSats comply with NASA orbital debris mitigation requirements and will generate the Orbital Debris Assessment Report (see [Chapter 6.1](#)) for all CSLI CubeSats.

All deliverables submitted by the CubeSat teams will be reviewed by the APIC. So, again, there isn’t much of a change for what your CubeSat team will need to do compared to the other mission models we’ve talked about so far: a member of your team will attend regular tag-up meetings with the APIC (the mission integrator), submit all required documentation to the APIC, and participate in a readiness review for final launch approval.



This is the launch of ELaNa-XII on October 8, 2015, as an auxiliary payload on the NROL-55 mission from Vandenberg Air Force Base, Calif. Four CubeSat missions were deployed: **BisonSat** from Salish Kootenai College, Pablo, Mont.; **Fox-1** from AMSAT, The Radio Amateur Satellite Corporation, Kensington, Md.; **ARC-1** from the University of Alaska Fairbanks, Alaska; and **LMRSTSat** from the Jet Propulsion Laboratory, Pasadena, Calif. [ULA]

3.4 Commercial Launch Service Through a Third-Party Broker Mission Model

CubeSat developers can purchase launches through third-party brokers on non-Government launches, usually on commercial or foreign missions. CSLI can also procure rides through a broker for payloads on commercial missions.

The requirements for these missions will come from the LV provider via the broker (see **FIGURE 13**). NASA LSP will not verify the CubeSat requirements; instead, the broker will either serve as mission integrator or assign one. The mission integrator will work with the CubeSat and launch vehicle representatives to create the CubeSat-to-dispenser ICD and determine the appropriate schedule for document and hardware deliverables. The mission integrator role for third-party broker missions will be similar to that of the NASA missions. The mission integrator for these missions may not require readiness reviews, but may instead track the status of document and hardware deliverables to verify that the CubeSats are ready for flight.



NASA will be responsible for ensuring that all CSLI CubeSats comply with NASA orbital debris mitigation requirements and will generate the Orbital Debris Assessment Report (see **Chapter 6.1**) for all CSLI CubeSats.

During an event Oct. 14, 2015, at the Agency's Kennedy Space Center in Florida, Garrett Skrobot, lead for the ELaNu missions for NASA's Launch Services Program, shows the size of the CubeSats that will be launched under NASA's contract award for the Venture Class Launch Services. Rocket Lab USA and Virgin Galactic were awarded contracts under the Venture Class Launch Services competition to send several CubeSats into space on flight profiles tailored to the needs of the CubeSats manifested on each launch. [NASA/ Kim Shiflett]

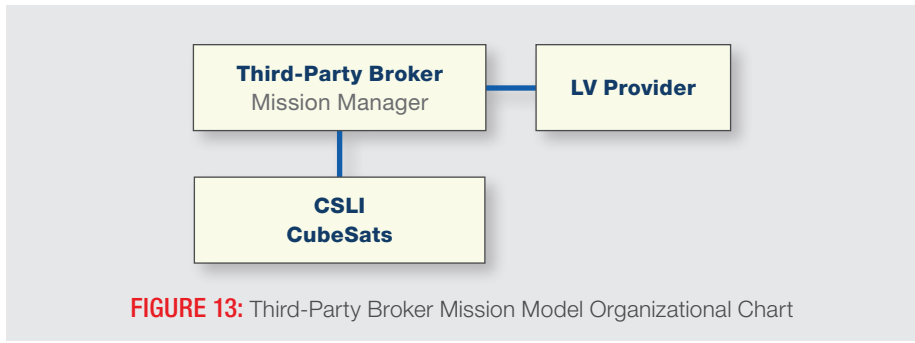

FIGURE 13: Third-Party Broker Mission Model Organizational Chart

3.5 International Space Station (ISS) Deployment Mission Model

In addition to riding as auxiliary payloads mounted directly to launch vehicles, CubeSats can also be deployed from the Space Station (see **FIGURE 14**). For this type of mission, the CubeSats are integrated into dispensers on the ground, transported to the ISS in a pressurized cargo vessel (e.g., SpaceX Dragon, Orbital ATK's Cygnus, etc.), and hand carried onto the ISS from the cargo vessel. Astronauts aboard the ISS are responsible for deploying the CubeSats from the ISS typically 1–3 months after arrival.

CubeSat mechanical and electrical requirements for ISS deployment are similar to those found in the CDS. For a list of requirements specific to ISS deployment, please visit the NanoRacks Web site at <http://nanoracks.com>. NanoRacks is currently the only commercial organization that can deploy CubeSats from the ISS. Any CubeSat using their services will need to comply with the current NanoRacks ICD. As with the other mission models, the CubeSats will submit flight safety review documents to the mission integrator, and the mission integrator will handle any reviews required by the ISS team.

NASA will be responsible for ensuring that all CSLI CubeSats comply with NASA orbital debris mitigation requirements and will generate the Orbital Debris Assessment Report (see **Chapter 6.1**) for all CSLI CubeSats.

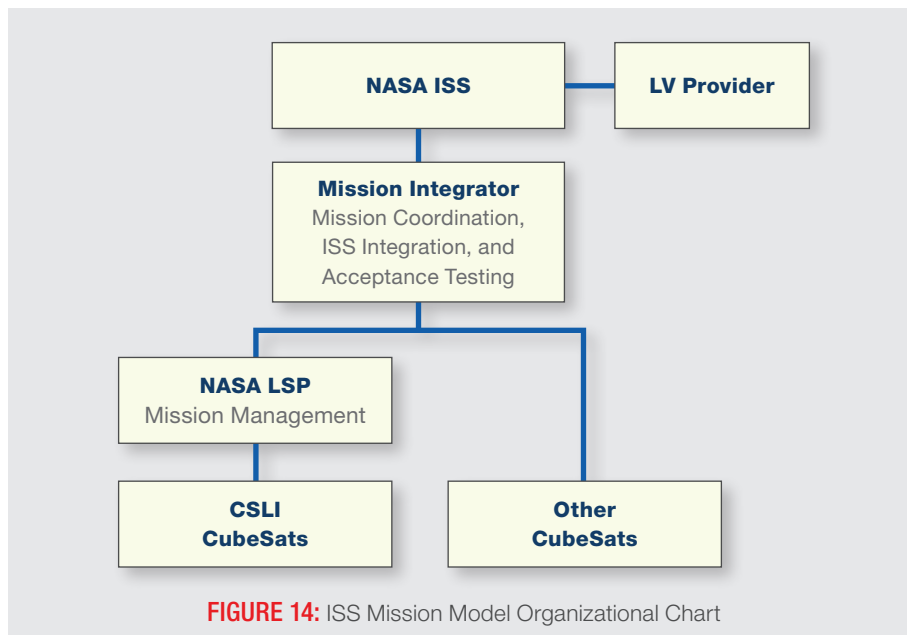

FIGURE 14: ISS Mission Model Organizational Chart

4 Requirement Sources for Launch

IN THIS CHAPTER

- 4.1 Mission-Specific Interface Control Documents (ICDs)
- 4.2 Launch Services Program (LSP)—Program-Level Requirements
- 4.3 CubeSat Design Specifications (CDS)
- 4.4 Dispenser Standards/Specifications
- 4.5 Federal Statutes
- 4.6 Range Safety Requirements

Unfortunately, you can't know all of the requirements your CubeSat will need to adhere to before you start your design process. The requirements for previous CubeSat launches have all been similar, but they do vary with every mission. You can, however, use some of the public documents that are discussed in this chapter as guidelines. The CubeSat-to-dispenser ICD (provided by the mission integrator after you've been manifested) lists your official requirements and is derived from these public documents and the dispenser-to-LV ICD, which is specific to your LV. You can use the information in documents like LSP-REQ-317.01, GSFC-STD-7000, and the CDS to help you get started, but **your final CubeSat design will need to meet all of the requirements in the mission ICD provided to you by the mission integrator.**

This chapter describes the documents involved in building your CubeSat's set of requirements. It's important for you as the developer to understand what these documents are and how they work together to form the requirements your CubeSat will need to meet to be certified for launch.

Pictured above:

St. Thomas More Cathedral School **STMSat-1** (1U) and **Nodes 1 and 2** (1.5U each) deployment from the International Space Station on May 16, 2016. [NASA]

4.1 Mission-Specific Interface Control Documents (ICDs)

As stated earlier, the mission-specific ICDs form the rulebook for your Cubesat. That is because these documents explicitly and officially state what your CubeSat’s requirements are for your particular launch. If your CubeSat fails to meet any of these requirements, your CubeSat may not get to fly.

CubeSat missions generally have two ICDs, one to regulate the CubeSat-to-dispenser interfaces, and one to regulate the dispenser-to-launch vehicle interfaces. The mission-specific CubeSat-to-dispenser ICD is usually generated and maintained by the mission integrator. It captures all of the requirements from all sources and typically includes the requirements from the dispenser-to-LV ICD, the CDS, range safety requirements, and any other applicable documents. The CubeSat-to-dispenser ICD will specify all of the environmental levels for which you will need to test your CubeSat. That includes, but is not limited to, vibration, shock, thermal vacuum, and acoustic environments.

4.2 Launch Services Program (LSP)—Program-Level Requirements

Before your mission ICD is available, you, as a CubeSat developer, will want to base your preliminary designs on the requirements in NASA LSP’s most recent revision of the Program Level Requirements (LSP-REQ-317.01). This set of requirements was developed specifically for CubeSats and dispensers integrated on NASA Primary Payload Missions where LSP has procured the launch vehicle (see the NASA-Procured Launch Vehicle Mission Model in [Section 3.1](#)). The purpose of these particular requirements is to ensure that the CubeSats and dispensers will contribute no added risk to the primary payload. These requirements will be incorporated into the mission ICDs. The latest revision of LSP-REQ-317.01 can be found on the NASA Web site (https://www.nasa.gov/pdf/627972main_LSP-REQ-317_01A.pdf).

4.3 CubeSat Design Specifications (CDS)

The CDS is a set of general requirements used to define a standard CubeSat. Developers can use the CDS in the preliminary design phase, but keep in mind that this is not the official set of requirements that your CubeSat will need to meet. The most recent version can be found at <http://www.cubesat.org>.



NASA LSP’s most recent revision of the Program Level Requirements LSP-REQ-317.0 Document. [NASA]



CubeSat Design Specifications Document [Cal Poly]

4.4 Dispenser Standards/Specifications

All CubeSat dispenser models on the market will accommodate a CubeSat designed to the requirements in the CDS, but each offers its own particular set of options. Before beginning the design process for your CubeSat, it would behoove you to research the differences between available dispensers. If you're already familiar with each dispenser, you'll be in a better position to make adjustments to your design when CSLI matches your CubeSat with a launch and specifies the dispenser that will be used. The specifications for each dispenser are located on their respective Web sites.

4.5 Federal Statutes

There are Federal laws regulating the use of CubeSats. Some are more obscure than others, but the most significant laws deal with radio frequency (RF) transmissions, orbital debris, re-entry risk, and Earth observation.

The Federal Communications Commission (FCC) is responsible for regulating all radio transmissions generated by non-Government U.S. entities, including CubeSat communications. The official document that specifies the FCC rules for CubeSats is in the Code of Federal Regulations (CFR). The specific chapter is 47 CFR Part 97, but if you'd like a more practical discussion of the licensing process, your team can refer to the Licensing Procedures chapter ([Chapter 5](#)) of this document.

The National Oceanic and Atmospheric Administration (NOAA) is the regulatory agency overseeing the remote sensing capabilities of non-Government orbiting spacecraft, including CubeSats. By "remote sensing," we mean any sort of sensing capability, like picture taking or imaging, that your CubeSat might have. NOAA is tasked with licensing all spacecraft that have remote sensing capabilities that could possibly catch an image of Earth. If you have a sensor that could possibly glimpse Earth, you must contact NOAA in order to know if your CubeSat requires a remote sensing license. NOAA is the sole determining authority of the need for a license. Operators and owners should always assume a license is needed. The Code of Federal Regulations at 15 CFR Part 960 covers the rules regarding this licensing process.

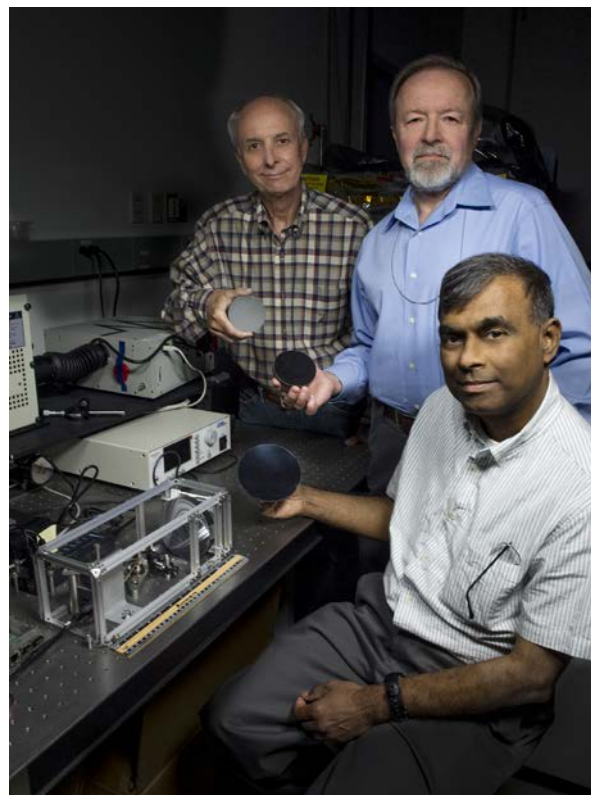

John Kolasinski (left), Ted Kostiuik (center), and Tilak Hewagama (right) hold mirrors made of carbon nanotubes in an epoxy resin. The mirror is being tested for potential use in a lightweight telescope specifically for CubeSat scientific investigations. [NASA/W. Hrybyk]

4.6 Range Safety Requirements

Anyone launching anything from a U.S. launch site must adhere to safety requirements intended to protect people and property on/in the surrounding land, sea and air. In the U.S., there are Government launch sites and commercial launch sites. Launches from U.S. Government launch sites within the Eastern (Kennedy Space Center and Cape Canaveral Air Force Station) or Western (Vandenberg Air Force Base) Ranges, must adhere to very particular safety requirements. These requirements can be found in the *Air Force Space Command Manual* (AFSPCMAN 91-710), the Air Force Occupational Safety and Health Standards (AFOSHSTD 48-9), and the Eastern Western Range Safety Requirements (EWR 127-1). If by chance you are launching from Wallops their *Range Safety Manual for Goddard Space Flight Center (GSFC) and Wallops Flight Facility (WFF)* will be used. Many of the requirements of these documents are encompassed in the CubeSat-to-dispenser ICD.

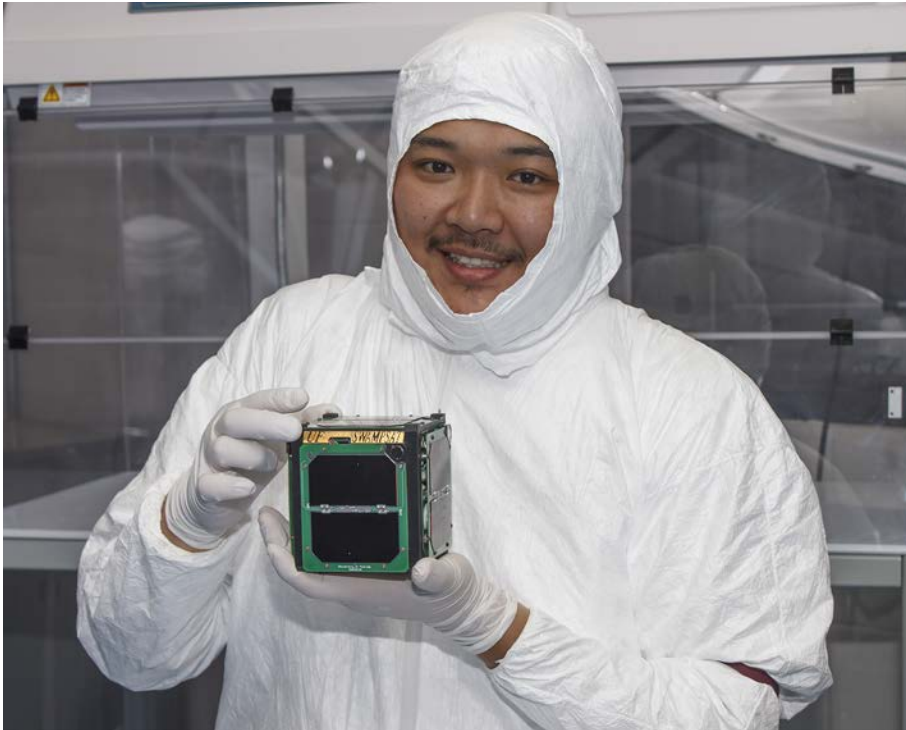

Student Bungo Shiotani from the University of Florida, Gainesville, working on the **SwampSat** CubeSat mission to demonstrate precision three-axis attitude control in orbit using a pyramidal configuration of control moment gyroscopes (CMG). The CubeSat was launched by NASA's CubeSat Launch Initiative on the ELaNa IV mission as an auxiliary payload aboard the U.S. Air Force-led Operationally Responsive Space (ORS-3) Mission on November 19, 2013. [University of Florida, Gainesville]

5 Licensing Procedures

IN THIS CHAPTER

- 5.1 Radio Frequency (RF) Licensing
- 5.2 Remote Sensing

We've explained the importance of obtaining proper licensing for your CubeSat. This chapter will help you determine which licenses to pursue and how to get them. Like we've stated before, any CubeSat that can transmit RF or take images and that is owned or operated by a U.S.-based organization will be required to obtain specific licenses and/or authorizations. For non-U.S.-based organizations, licensing of RF operations will be required by the organization's national regulatory authority.

➔ **As you develop your CubeSat, you should check the source references provided in each chapter to verify that you are following the current procedures and requirements.** The rules and requirements change over time, and you will need make sure you are up-to-date so that your licensing process goes as smoothly as possible.

5.1 Radio Frequency (RF) Licensing

CubeSat licenses have different classifications depending on who the primary operator of the CubeSat will be and how it is to be used. Each classification has its own set of requirements and procedures. In this chapter, we'll help you understand the differences between the types of licenses and which will be appropriate for your CubeSat mission.

While it's not critical for you to know everything that goes on behind the curtain, you may want to have an idea of how your paperwork is being processed. You can find information online about CubeSat licensing. There are a number of

Pictured above:

University of Kentucky students Jason Rexroat and Alex Clements working on **KySat-2** a technology demonstration CubeSat mission developed by students from the University of Kentucky in Lexington, Kentucky that builds upon KySat-1 by expanding the K-12 outreach goals to interest students to science, technology, engineering and mathematics (STEM) fields and space technology. It also will test components of a novel attitude determination system called a Stellar Gyroscope that uses sequences of digital pictures to determine the three-axis rotation rate of the satellite. Launched by NASA's CubeSat Launch Initiative on the ELaNa IV mission as an auxiliary payload aboard the U.S. Air Force-led Operationally Responsive Space (ORS-3) Mission on November 19, 2013. [University of Kentucky]

Web sites run by amateur operators, other developers, and Government agencies (FCC, NASA Spectrum, etc.) that break down the licensing process in greater detail. More comprehensive information can be found in FCC¹ and NASA Spectrum² guidance documents.

Prior to finalizing any design, operations plans or submitting license requests, you should understand the core regulatory rules including technical constraints that are in place to enable sharing between systems in certain frequency bands. You do not want to design and build a system that violates regulatory rules since during the licensing process you may not be able to correct any issues found. Projects may want to consult with organizations or individuals familiar with spectrum regulations during the design phase to ensure compliance. Depending on the type of mission, the mission integrator may also help your team obtain the RF license for your CubeSat.



Students from the University of Michigan holding **The Geostationary Coastal and Air Pollution Events (GEO-CAPE) Read-Out Integrated Circuit (ROIC) In-Flight Performance Experiment (GRIFEX)** 3U CubeSat mission developed by the Jet Propulsion Laboratory and students from the University of Michigan who will perform engineering assessment of a JPL-developed, all digital, in-pixel high frame rate ROIC. Launched by NASA's CubeSat Launch Initiative on the ELaNa X as an auxiliary payload aboard the Soil Moisture Active Passive (SMAP) Mission on January 31, 2015. [University of Michigan]

License Types

- **Amateur:** Designed specifically for amateur radio enthusiasts and to serve the amateur radio community.
- **Commercial:** For commercial use, not applicable for non-commercial university-based CubeSats or CSLI selectees.
- **Experimental:** For radio frequency emitting systems on spacecraft containing experiments. Typical license for university CubeSats or CSLI selectees.
- **Government:** For spacecraft that operate radio frequency systems that “belong to and are operated by” any U.S. Government agency.

1 FCC Guidance on Obtaining Licenses for Small Satellites (DA: 13-445) (<http://www.fcc.gov/document/guidance-obtaining-licenses-small-satellites>)

2 Spectrum Guidance for NASA Small Satellite Missions (https://www.nasa.gov/directorates/heo/scan/spectrum/policy_and_guidance.html)

Amateur—FCC Part 97

This is the simplest case, but the most difficult to qualify for; very few CubeSats qualify for purely amateur designation. This designation is intended for satellites that will be used by amateur operators only. There can be no Government or commercial involvement in the development or operation of the CubeSat. So, if your CubeSat project is being funded by a Government grant, you are disqualified from getting an amateur designation. **It's important to note that, when determining amateur status, the FCC focuses on who the operator is, and NOAA focuses on who the owner of the CubeSat is.**

Amateur satellites are typically used to help operators to self-train and perform intercommunication and technical investigations. The satellite operates within a range of frequency bands that are allocated to the Amateur-Satellite Service, which have been set aside for radio operators with purely noncommercial purposes. One group that consistently develops amateur CubeSats is the Radio Amateur Satellite Corporation (AMSAT). They're a largely volunteer group interested in advancing space education, science, and technology. If you're interested in learning what an amateur class CubeSat project looks like, you can visit their Web site, <http://www.amsat.org/>.

A satellite with an amateur license isn't limited to transmitting over the United States; this means that the satellite can communicate with ground stations located anywhere in the world. The transmissions cannot be encrypted in any way and must consist of open information (i.e., nothing that's supposed to be a secret or proprietary). The eligibility rules are listed in 47 CFR Part 97.

Unlike other licenses, an amateur satellite license is not a stand-alone license, but an addition to the radio operator's existing amateur license. Although the operator does not have to obtain a new license, and there is less paperwork to complete, it is not a trivial process. Any person who will be operating an amateur satellite is required to have an amateur operator license. Information on how to obtain this license for your team members can be found on the FCC's Web site.

Any amateur (or experimental-licensed) spacecraft that use frequency bands allocated to the Amateur-Satellite Service must coordinate with the International Amateur Radio Union (IARU). Immediately after the CubeSat is manifested, if not earlier, a frequency coordination request should be sent to the IARU to ask for a frequency assignment for the CubeSat transmitter. Information can be found on the IARU Web site at <http://www.iaru.org/satellite.html>. Because the IARU is made up of volunteers across the world, they only meet periodically to review

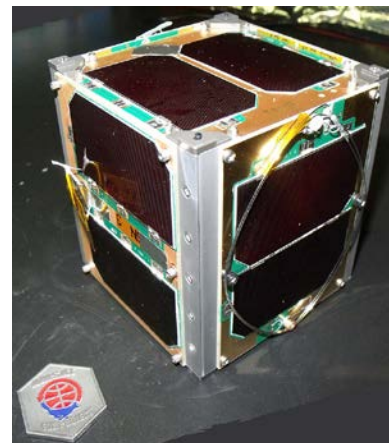

The AMSAT **Fox-1** CubeSat primary focus was education and it hosted a communications package specifically designed to be easy-to-use, requiring only a simple walkie-talkie-style radio combined with a small hand-held antenna. Using amateur radio frequencies, it was open and available to the general public. Fox-1 was launched by NASA's CubeSat Launch Initiative on the ELaNa XII mission as an auxiliary payload aboard the NROL-55 Mission on October 8, 2015. [AMSAT]

applications. This means each review cycle can take a significant amount of time. Thus, it is strongly suggested that you have someone with previous experience working with the IARU to review your application before you submit it, in order to reduce the likelihood of your application being kicked back for corrections. IARU will respond to your frequency coordination request with a coordination letter that will identify the frequency to which your CubeSat has been assigned.

As soon as you have your frequency assignment letter from IARU, you will be able to assemble the FCC documentation. The licensed amateur operator will need to submit what's referred to as a prelaunch notification no later than 30 days after being manifested. If there's only a short timeframe between manifest and integration to the launch vehicle, then the prelaunch notification must also be submitted (no later than 90 days before integration).

DID YOU KNOW?

What's the IARU?

The International Amateur Radio Union (IARU) is an international agency run by volunteers who are based in countries around the world, who coordinate what group will be allowed to use which radio frequencies in the amateur band. As you can imagine, lots of people are transmitting for various reasons all day, everyday. To avoid transmissions interfering with each other by using the same frequency, IARU keeps track of which amateur frequencies are available and assigns the unused bands upon request. That's why the FCC requires CubeSat developers to contact the IARU for an amateur frequency assignment before an RF license can be processed.

For an amateur license, the FCC will need the following:

- IARU coordination letter
- Satellite orbital debris mitigation compliance document (discussed in [Chapter 6](#))
- **SpaceCap notice:** the SpaceCap software can be downloaded from <http://www.itu.int>)
- Prelaunch notification letter with general mission and satellite information

Note: *The FCC won't request your SpaceCap file until after the initial application submission.*

On certain types of missions, the above information is e-mailed by the mission integrator to the FCC International Bureau and copied to amsat.spacecap@fcc.gov.

SpaceCap notice: The Space notification system PC Capture, or SpaceCap, is a software file containing information about transmitting stations in space, including details about antennas, transmitters, and the station itself. The file is created by PC-based software that can be downloaded for free from the International Telecommunications Union (ITU) Web site.

Experimental—FCC Part 5

Although very few CubeSats qualify as purely amateur radio stations, non-Federal CubeSats that involve radio frequency use “for the purposes of experimentation, product development, and market trials,” not commercial operations, may seek licensing under the FCC experimental licensing rules (Part 5). Most university or nonprofit organization based systems, such as those supported by NASA’s CubeSat Launch Initiative, qualify for FCC experimental licensing.

The process for submitting an experimental license application depends on the duration of the mission.

- **Special Temporary Authority (STA) Form** should be used for experiments lasting less than six months. The STA application form is online: <https://apps.fcc.gov/oetcf/els/forms/STANotificationPage.cfm>
- **Form 422** should be used for experiments lasting longer than six months. The process for submitting an application for FCC experimental licensing is described online at <https://apps.fcc.gov/oetcf/els/forms/422Entry.cfm>.

Experimental licenses are not limited to a particular frequency band; however, CubeSats using frequency bands allocated to the Federal Government on an exclusive or shared basis are required to coordinate with U.S. Federal agencies. The FCC will initiate this coordination as part of the application process; however, projects are highly encouraged to seek guidance prior to developing any systems in such bands. Careful attention must be made since special circumstances may apply. In addition, CubeSats using frequency bands allocated to the Amateur-Satellite Service must coordinate with the IARU (see Amateur section about IARU coordination).

➔ CubeSats must also comply with technical constraints as specified by FCC regulations. **Experimentally licensed CubeSats must operate on a non-interference basis neither causing interference to or claiming interference from fully licensed systems.** To address any possible interference, FCC regulations require that all CubeSats have the capacity to cease emissions. To enable sharing in some

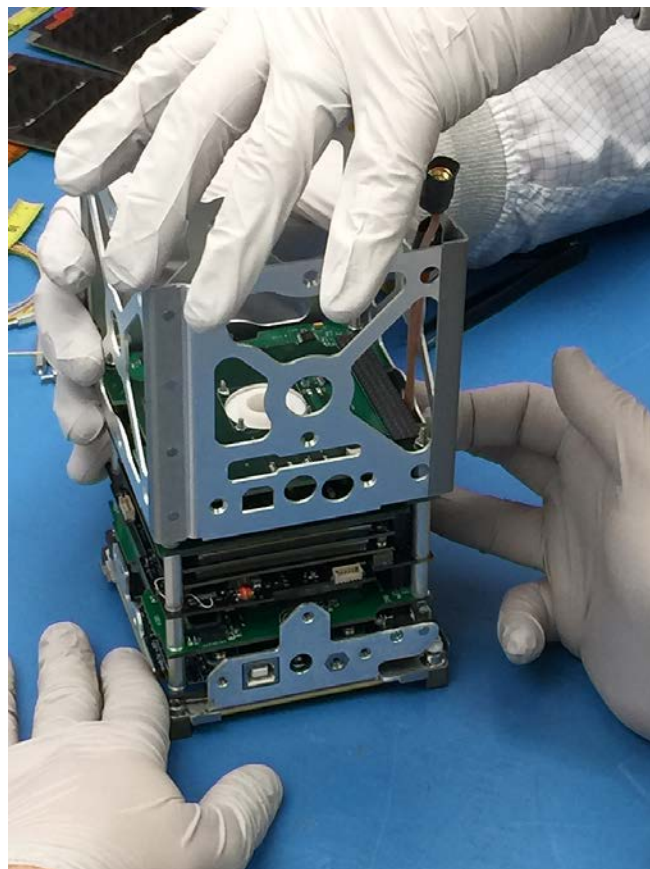

The **BisonSat** mission is an Earth Science mission that will demonstrate the acquisition of 100-meter or better resolution visible light imagery of Earth using passive magnetic stabilization from a CubeSat. BisonSat is the first CubeSat designed, built, tested, and operated by tribal college students. Launched by NASA’s CubeSat Launch Initiative on the ELaNax II mission as an auxiliary payload aboard the NROL-55 Mission on October 8, 2015. [Salish Kootenai College]

bands, CubeSats may also need to limit emissions below certain power levels. These are just a couple of the types of constraints that projects need to consider in the design and operations of radio frequency systems.

Cubesat developers are responsible for gathering all necessary information required for licensing prior to submitting a license request—delays in licensing are often due to incomplete data.

For an experimental license, the FCC will need the following:

- **Form 442 or STA form:** containing directed questions concerning general mission, satellite and radio frequency equipment information; additional information may also be needed;
- **EXHIBIT:** If a Government contract is involved, a narrative statement describing the contract circumstances
- **EXHIBIT:** Research project and/or experimental purpose description including detailed information about communication facilities and operations (e.g., ground support)
- **Satellite orbital debris mitigation compliance document** (discussed in *Chapter 6*)
- **IARU coordination letter:** for systems using Amateur-Satellite Service bands
- International Telecommunication Union (**ITU Cost Recovery letter:** projects are responsible for paying the fees for international coordination filings
- **Fee-exempt status letter** (if applicable)
- **NOAA Remote Sensing license:** or letter indicated that such licensing is not needed
- **SpaceCap notice:** the SpaceCap software can be downloaded from <http://www.itu.int>.

Note: *The FCC won't request your SpaceCap file until after the initial application submission.*



Chuck Clagett, Larry Kepko, and Michael Johnson were instrumental in developing the **Dellingr** 6U CubeSat shown here inside NASA's Goddard Space Flight Center magnetic calibration facility. Dellingr was manifested on the ELaNa 22 mission that launched on the SpaceX-12 on August 14, 2017. [NASA/W. Hrybyk]

As with the other types of licenses, the application process for an experimental license needs to start as soon as possible—preferably within 30 days after your CubeSat is manifested or earlier. The FCC requires a minimum of 90 days from the receipt of your application to issue a license, therefore complete FCC applications should be submitted in a timely manner.

Before your application can be submitted, CubeSats using frequency bands allocated to the Amateur-Satellite Service must send an experimental coordination request to the IARU asking for a frequency assignment for the CubeSat transmitter. This should be done immediately after the CubeSat is manifested, if not earlier. That is because the IARU is made up of volunteers from across the world and they only meet periodically to review applications. This means each review cycle can take a significant amount of time. Thus, it is strongly suggested that you submit your request early and have someone with previous experience working with the IARU to review your application before you submit it, in order to reduce the likelihood of your application being kicked back for corrections. When your application has been approved, the IARU will then send you a coordination letter identifying which frequency the satellite has been assigned.

Once you receive the assignment letter, you will be able to begin assembly of the application packet for the FCC. The process for submitting an application for experimental licenses is very similar to the process for applying for an amateur license, but instead of a prelaunch notification, you will need to submit FCC Form 442 online or if your mission is expected to operate for less than 6 months, a Special Temporary Authority (STA) form can be submitted instead. The appended documents are the same, but the STA application requires less information from the applicant.

➔ **The FCC requires a minimum of 90 days from the receipt of your application to license issuance, therefore—and this can't be stressed enough—FCC applications should be submitted ASAP.**

Complete, detailed information is necessary otherwise license requests will bring about lengthy queries seeking additional information. Early, but incomplete license submissions do not confer any benefits. All required data for licensing should have been gathered and reviewed during the requirements, design, and review phases, so there is no reason not to have a complete application prior to the time needed to file.

Commercial Satellite—FCC Part 25

Satellite operations for commercial purposes must obtain licensing through FCC Part 25 processes. This document does not address such commercial systems.

Note: U.S. Government entities are prohibited from using FCC licenses for CubeSat operation.

Government

The process for obtaining a Federal Government CubeSat certification and authorization is different from the process for securing FCC licensing. The NTIA is the governing agency for Federal Government satellites (i.e., satellites that “belong to and operated” by a Federal agency), so there is no need to submit an FCC application. The frequency authorization process is well defined by the *NTIA Manual of Regulations and Procedures for Federal Radio Frequency Management* (available online on the NTIA Web site³). Your CubeSat's team will work directly with the appropriate Federal agency Spectrum Management Office to pursue system spectrum certification and frequency authorization. For example, NASA CubeSat



CXBN, the Cosmic X-Ray Background NanoSat was developed and built by students from Morehead State University in Kentucky. Its primary purpose is to increase the precision of measurements of the Cosmic X-Ray Background in the 30–50 KeV range. Launched by NASA's CubeSat Launch Initiative on the ELaNa VI mission as an auxiliary payload aboard the NROL-36 Mission on November 13, 2012. [Morehead State University]

³ <https://www.ntia.doc.gov/page/2011/manual-regulations-and-procedures-federal-radio-frequency-management-redbook>

teams would work with their NASA Center's Spectrum Office. The mission integrator will have little to do with this type of licensing process, aside from regularly bugging you about the status. For missions designated as NASA (Federal), detailed information about the process can be found in the NASA/Spectrum⁴ guidance document.

5.2 Remote Sensing

Not all CubeSats will need a remote sensing license from NOAA, **but if you have a non-Federal Government CubeSat with any type of active or passive imager, you must obtain a remote sensing license from NOAA's Commercial Remote Sensing Regulatory Affairs (CRSRA)**. While the mission integrator will help with the RF licensing process on some types of missions, CubeSat developers are solely responsible for obtaining the remote sensing license from NOAA CRSRA.

You should start the process of applying for a remote sensing license by filling out the one-page Initial Contact Form, found on the NOAA CRSRA Web site at <http://www.nesdis.noaa.gov/CRSRA>. After NOAA has reviewed the form, they will determine if your sensors require a license. If a license is required, they will contact you for further information. Once NOAA has made their determination either way, they will notify your team by letter or e-mail.

If a license is required, your team must send a written application to the Assistant Administrator, NOAA Satellite and Information Services. Contact information can be found on the NOAA CRSRA Web site at <http://www.nesdis.noaa.gov/CRSRA>. There is no application form, but the required information is listed in Appendix 1 of 15 CFR Part 960. Submissions should be compiled in the same order as listed in the appendix, and all fields in the application must be addressed even if the answer is “none” or “N/A.”

For imagers designed to only take images of Earth, the application process is fairly straightforward, and approval takes approximately 120 days following submission (separate from the initial contact form). NOAA will provide feedback on draft applications prior to formal submission to help smooth out the process. If the CubeSat is to image anything other than Earth (i.e. other CubeSats, LV

⁴ Spectrum Guidance for NASA Small Satellite Missions (https://www.nasa.gov/directorates/heo/scan/spectrum/policy_and_guidance.html)



Students from the University of Colorado Boulder sharing information about the **MinXSS** mission with NASA Administrator Charlie Bolden. MinXSS is a science investigation to study solar flares, active regions, the quiescent Sun, and their impact on Earth's upper atmosphere built by students from the University of Colorado at Boulder. Launched by NASA's CubeSat Launch Initiative on the December 6, 2015 ELaNa IX mission on the fourth Orbital-ATK Cygnus Commercial Resupply Services (CRS) to the Space Station and deployed on May 16, 2016. [University of Colorado at Boulder]

upper stage during deployment, etc.), an NEI (Non-Earth Imaging) waiver will need to be submitted as part of your application, which can add a significant amount of time to the application process. Be sure to notify the mission integrator as soon as possible of the details of your NOAA application. If the application needs to be updated during the process, especially to add an NEI waiver, this will restart the process from the beginning, so be sure to consider the mission operations prior to submitting your application.

WARNING!

If your licenses are not finalized before your CubeSat is integrated into its dispenser, your CubeSat will not fly on that mission. It's crucial to follow up on all paperwork and make sure there are no delays in the process.

As a CubeSat operator, you will have some post-launch licensing responsibilities. You must maintain the imaging license by submitting to regular audits and on-site inspections of the CubeSat's ground station and mission control center. The auditor will check to make sure you've maintained the security precautions that were specified in your license approval.

6 Flight Certification Documentation

This is where the rubber meets the road: now you must show the mission integrator, and CSLI, that your CubeSat is ready to fly. Each CubeSat developer will need to supply specific documentation (i.e., deliverables or verification evidence) showing that their CubeSat meets all of the requirements of the mission. The mission integrator will receive the deliverables and verify all requirements have been met. When all items have been submitted and accepted, the approval for flight can be granted. Typically, the first of the deliverables will be due about 10 months before the CubeSat is to be delivered to the integration site.

It is possible that your CubeSat design will change slightly during the mission cycle (i.e., the time between mission kickoff and CubeSat delivery), so **it's important to keep the mission integrator aware of all changes and issues encountered during the development of your CubeSat.**

This chapter will outline the documents and describe the content typically required for approval for flight. But remember, the mission integrator will supply your team with the official list of deliverables for your mission, as well as specific information that must be included in each document.

IN THIS CHAPTER

- 6.1 Orbital Debris Mitigation Compliance
- 6.2 Transmitter Surveys
- 6.3 Materials List
- 6.4 Mass Properties Report
- 6.5 Battery Report
- 6.6 Dimensional Verifications
- 6.7 Electrical Report
- 6.8 Venting Analysis
- 6.9 Testing Procedures/Reports
 - 6.9.1 Day In The Life (DITL)
 - 6.9.2 Dynamic Environment Testing (Vibration/Shock)
 - 6.9.3 Thermal Vacuum Bakeout Testing
- 6.10 Compliance Letter
- 6.11 Safety Package Inputs (e.g., Missile System Prelaunch Safety Package, Flight Safety Panel)

Pictured above: **ASTERIA** spacecraft final closeout at the Jet Propulsion Laboratory. [JPL]

Flight Certification Documentation List

1. Orbital Debris Assessment Report (ODAR), or similar, showing compliance inputs
2. Transmitter surveys
3. Materials list
4. Mass properties report
5. Battery report
6. Dimensional verifications
7. Electrical report
8. Venting analysis
9. Testing procedures/reports
10. Compliance letter
11. Safety package inputs (e.g., Missile System Prelaunch Safety Package—or MSPSP, flight safety panel)

6.1 Orbital Debris Mitigation Compliance

Orbital debris mitigation compliance is documented in an Orbital Debris Assessment Report (ODAR), or similar document (however, for the purposes of this guide, we'll call everything an ODAR), and is the document that assures all interested parties that your CubeSat won't pose an unacceptable hazard to other orbiting spacecraft, will deorbit in a reasonable amount of time, and that no unacceptably large piece of your CubeSat is going to survive reentry when it deorbits and burns up in the atmosphere. The ODAR demonstrates compliance with FCC, NOAA, or NASA requirements for safing and/or disposal of the spacecraft and orbital debris mitigation requirements. The documentation required depends on which U.S. Government agency has "jurisdiction" over your CubeSat as an on-orbit satellite. In general, if you will be required to get an FCC license, then you will need to meet the FCC's regulations on orbital debris mitigation and provide a publicly-releasable document for their records. For CSLI CubeSats, this has traditionally been satisfied by providing the FCC the CubeSat-specific appendix from the mission's ODAR developed by NASA LSP (see next paragraph).

For CSLI CubeSats, an ODAR document will be generated by NASA LSP using information provided by the CubeSat developer. The CubeSat developer will provide documents that include a mission description (including an expanded view image of the spacecraft) and a list of all components on the satellite, identifying the mass, shape, volume, and material of each. Be sure to note in the components' descriptions any hazardous and exotic materials, propulsion, pressure vessels, and power storage (include any UL numbers for batteries). Templates for each of these two documents can be found in [Appendix C](#).

> FREE ADVICE

CHOOSE LOW MELTING POINTS. It is strongly recommended that you avoid the use of materials with high-melting points in your CubeSat design (e.g., use aluminum and steel as opposed to tantalum, titanium, or tungsten). If any of your satellite's materials survive reentry, they pose a threat to people and property. Use of such materials could lead to a constraint in licensing requiring you to purchase insurance for such an unfortunate occurrence.

For non-Government, non-CSLI CubeSats flying on a mission that requires the CubeSat developer to provide their own ODAR, the developer should reference the FCC requirements in the Code of Federal Regulations at 47 CFR 25.114(d) (14)⁵ and, as appropriate, the NOAA requirements at 15 CFR 960 (Appendix 1 to Part 960, Section V,C).⁶ The developer may use NASA's Debris Assessment Software (DAS) to complete the analysis and report. You can find the software here: <https://www.orbitaldebris.jsc.nasa.gov/mitigation/das.html>. The DAS User's Guide gives step-by-step instructions on how to use DAS to complete the assessment. Note that the FCC's and NOAA's requirements are, for the most part, a subset of the requirements imposed by NASA on NASA projects.

Drafts of your ODAR documentation will likely be among the first deliverables due. Changes in design as development continues will mean you need to revise and resubmit the documents. Without an approved ODAR, NOAA and FCC licenses will not be granted, and the CubeSat cannot be approved for flight.

6.2 Transmitter Surveys

The transmitter survey is a series of questions about the CubeSat's communication system. The information from the survey will be used to help the LV provider perform EMI/EMC analysis and will be included in the MSPSP (see [Chapter 6.11](#)) to verify that the CubeSat meets RF inhibit requirements. A template for this document can be found in [Appendix C](#).

A draft of this deliverable will likely be another of the first documents due. If you make any changes in your design relevant to the transmitter after the transmitter survey is submitted, you will need to revise and resubmit the document.

6.3 Materials List

The materials list will be used on CSLI missions to verify that no dangerous or prohibited items have been incorporated into your CubeSat design. The materials list is usually a Word document identifying every material used on the CubeSat



The St. Thomas More Cathedral School students working on **STMSat-1**, an education mission to provide hands-on, inquiry-based learning activities with an on-orbit mission to photograph the Earth and transmit images to their primary ground station and to remote ground stations throughout the country. STMSat-1 was the first CubeSat NASA launched for a primary school. Launched by NASA's CubeSat Launch Initiative on the December 6, 2015 ELaNa IX mission on the fourth Orbital-ATK Cygnus Commercial Resupply Services (CRS) to the Space Station and deployed on May 16, 2016. [St. Thomas More Cathedral School]

⁵ <https://www.gpo.gov/fdsys/pkg/CFR-2016-title47-vol2/pdf/CFR-2016-title47-vol2-part25-subpartB.pdf>

⁶ <https://www.gpo.gov/fdsys/pkg/CFR-2017-title15-vol3/pdf/CFR-2017-title15-vol3-part960.pdf>

along with its mass (or expected mass), its location on the CubeSat, and its **outgassing** properties including Total Mass Loss (TML) and Collected Volatile Condensable Materials (CVCM). NASA has published outgassing properties for most materials used in CubeSats; this information can be found at <http://outgassing.nasa.gov>. Most ICDs use the outgassing limits identified in the CDS requirements. A template for this document can be found in *Appendix C*.

Like the ODAR documents, a draft of this document will likely be among the first deliverables due. Any changes in your design during the development will require revision of the document and resubmission.

6.4 Mass Properties Report

The mass properties report identifies the CubeSat's total mass, center of gravity (CG), moments of inertia (MOIs), and products of inertia (POI) relative to each axis. The first draft of this report will be among the first deliverables due. This gives the mission integrator and the LV provider adequate time to use the mass property information in their analyses. The LV provider will use your initial mass estimates for their own LV load calculations. The mass properties that your CubeSat ends up with after being built must remain within your expected tolerances so that the LV provider's calculations will remain valid.

The first draft of the report will be reviewed to ensure the predicted mass and CG locations meet the ICD requirements. The final mass properties report will include the CubeSat's measured total mass and must be submitted as soon as possible after the final flight unit is complete.

If your final mass properties numbers are out of tolerance, it's possible the CubeSat will be demanifested. This is because a mass that is outside of the LV provider's analysis creates an unknown risk to the LV and its primary mission.

In addition to providing mass properties information, the mass properties report will typically be used to verify the CubeSat's coordinate system with a drawing or schematic included in the report.

outgassing: In the spacecraft industry, outgassing refers to the sublimation or evaporation of materials as those materials are taken to a high-vacuum environment like space. The material that is lost to outgassing can find its way onto sensitive components and possibly affect a mission's success.

> FREE ADVICE

CHOOSE LOW-OUTGASSING. When designing your CubeSat, use materials that are considered "low-outgassing." If you do this, it's possible that your team can avoid performing a thermal vacuum bakeout (see *Chapter 6.9.3, Thermal Vacuum Bakeout Testing*). The bakeout is a prelaunch measure used to force the CubeSat components' materials to outgas in a safe laboratory environment.

> FREE ADVICE

CAREFULLY CONSIDER THE MASS ESTIMATE MARGINS. When you submit your data estimates for the early LV provider's analyses, be sure to include large, but still reasonable, margins on all values. (Check with your mission integrator for advice on margins for your estimated values.) When the first mass properties draft is due, most CubeSats are still in the development stages, so it's not unusual for designs to change and thus affect the mass properties.

6.5 Battery Report

The information provided in the battery report will be used to verify that proper battery circuit protection is in place. Some mission integrators will require a standalone report, while others may review a portion of the MSPSP in place of the standalone report (the MSPSP will include all of this information). The mission integrator will sometimes require a battery lot testing report as well.

Specific information required for the battery report is listed below.

- Battery dimensions
- Battery UL number
- Manufacturer specification sheet
- Manufacturer part number
- Mass
- Battery model number
- Battery manufacturer
- Number of cells and their configuration (i.e., wired in series or parallel)
- Discharge characteristics
- Charge characteristics
- Lithium battery short circuit test
- Safety circuit diagram
- If battery has been modified, provide all modification documentation
- Technical datasheet that verifies battery circuit protection exists for battery charging/discharging



Daniel Perez, Ph.D., a graduate student from the University of Miami, displays a piece of the prototype structure for a new solid-state battery in the Prototype Laboratory at NASA's Kennedy Space Center in Florida. The size of the battery is so small that it could be a prime candidate for use in microsatellites, including CubeSats. [NASA]

6.6 Dimensional Verifications

Your CubeSat will be expected to adhere to the dimensional requirements specified in the CubeSat-to-dispenser ICD. The mission integrator will require the developer to perform a dimensional check after assembly, and prior to any environmental testing, to ensure the CubeSat will fit into its flight dispenser. It's important to check your CubeSat's dimensions often (before and after environmental testing at a minimum).

A dimensional checklist example (CubeSat Acceptance Checklist, or CAC) can be found in [Appendix C](#). This is not an official template and may differ significantly from what your mission integrator provides you, but it will give you an idea of what will be expected.

6.7 Electrical Report

An electrical report will be used to verify a number of requirements listed in the CubeSat-to-dispenser ICD (e.g., number of RF inhibits, CubeSat being self-contained).

Specific information typically required for the electrical report is listed below.

- Diagram of the electrical power systems
- Highlights for the electrical inhibits within the electrical diagram
- Identification of real-time clock circuitry within the diagram (if applicable)
- Identification of the **Remove Before Flight (RBF) pin** within the diagram (if applicable)
- Identification of the **separation switch(es)** within the diagram (if applicable)
- Clear explanation of the number of **inhibits** and how they function

6.8 Venting Analysis

As the launch vehicle ascends out of the atmosphere, it does so quickly, and the surrounding air pressure decreases quickly. It is a concern that somewhere inside your CubeSat is a trapped pocket of air that could possibly burst through the structure during ascent. This could create a dangerous situation for the LV and other payloads on the launch.

The venting analysis deliverable is a relatively simple report that uses diagrams and some basic mathematics to show the mission integrator that your CubeSat has adequate venting to prevent the explosive decompression of any container in your CubeSat as it makes the quick transition from standard atmosphere to vacuum.

The venting analysis will clearly identify the ventable and non-ventable volumes, and the venting area locations on the CubeSat. It will show that the internal

Remove Before Flight (RBF)

pin: The RBF pin is a physical object that separates the CubeSat's power system from the rest of the circuitry (particularly the central processor). Ideally, the RBF pin is removed after the CubeSat is integrated into the flight dispenser, but it can be removed just prior to integration.

separation switches: The separation switches on the CubeSat are usually located on the ends of the CubeSat rails. When depressed (as they will be in the dispenser) they will physically separate the power system circuitry from the rest of the CubeSat circuitry. When the CubeSat is ejected from the dispenser into orbit, the switches will no longer be depressed and will allow the CubeSat circuitry to connect to the power system.

independent inhibit: An inhibit is a physical device between a power source and a hazard. A timer is not considered an independent inhibit.

volume of air will safely evacuate through these venting locations. The CubeSat-to-dispenser ICD will typically have a requirement for the acceptable venting rate. If there are any volumes that cannot meet the requirement, additional analysis or testing may need to be performed by the CubeSat developer to show that the structure is strong enough to handle the change in external air pressure.

The mission integrator will likely provide a report template to the CubeSat teams on any CSLI mission.

6.9 Testing Procedures/Reports

A report will need to be submitted for each test used to verify CubeSat-to-dispenser ICD requirements. The reports will state which requirements are being verified and the specific evidence in the report that verifies each requirement. A copy of the signed, as-run test procedures should be included in the report, along with pictures of the as-run test setup. These reports will likely be the last deliverables submitted, since they can only be written after completion of the flight unit build. Generally, any data gathered from informal testing on an engineering unit does not need to be included in this report.

It's important to report any anomalies encountered during and after testing, (including informal testing). So, what qualifies as an anomaly? An anomaly is anything that affects the ability of your hardware to meet the requirements, such as: damage to any part of the CubeSat, unexpected release of deployables, strange rattles, unexpected transmissions, evidence of unexpected power-on, or anything else that could impact your schedule including anomalies with the test apparatus itself. When in doubt, ask the mission integrator. If an anomaly occurs during testing, you should stop the test, notify the mission integrator immediately, and discuss paths forward before proceeding.

6.9.1 Day In The Life (DITL) Testing

This test shows that your CubeSat's electronics and flight software work as expected. The ICD will have requirements for when the CubeSat is allowed to release its deployables and when it can start transmitting after being ejected from the dispenser. It will also have requirements on the minimum number of inhibits that will prevent early power-up of the CubeSat systems. This test will verify all of those things.

> FREE ADVICE

GET FEEDBACK ON TEST PROCEDURES BEFORE TESTING. It's advisable, and may be required, to send your testing procedures to the mission integrator for review before your team starts testing. If there's anything vital that's missing in the procedures, the mission integrator will catch it and have you correct the issue before you start. If you don't have your test plans reviewed before testing, it's entirely possible that you will have to retest your flight hardware.

The DITL report will show that the CubeSat's timers and inhibit design function correctly, adhering to the appropriate mission ICD requirements. This test must be run with the final flight software and in most cases will be required to be completed prior to environmental testing. This will allow the CubeSat to demonstrate when the deployables will be released without invalidating the vibration testing.

➔ **After you've completed the DITL testing, you are not allowed to change any piece of code in the software for any reason.** Doing so will invalidate your test, and the mission integrator will require you to perform a retest and submit a new test report.

The mission integrator will supply a report template, possibly with a generic set of procedures, but the test will need to be tailored to your CubeSat's specific inhibit structure. Your test procedure must be approved by the mission integrator prior to testing.

Minimum Report Content

- As-run procedures with all steps time stamped
- Proof that separation switches function as required
- Proof that timers function as required
- Simulation of flight-like release of deployables
- Time of deployment
- Time of first transmission

Note: *If you don't want your CubeSat to release its deployables for this test, you only need to show that they won't be released within the minimum post-deployment time specified in the CubeSat-to-dispenser ICD.*

6.9.2 Dynamic Environment Testing (Vibration/Shock)

The ride up to space on a typical LV can be pretty bumpy. Your CubeSat will be subjected to a dynamic environment that shakes it really hard. The strength of these levels of vibration or shock can be higher or lower depending on the specific LV and the dispenser mounting configuration on the LV. The point of dynamic environment testing (also called environmental testing) is to show that your CubeSat will survive the vibrations and shocks that it will experience during launch. The CubeSat-to-dispenser ICD will specify the levels at which you'll need to shake your CubeSat for this test, as well as how long the test will need to last.

DID YOU KNOW?

How DITL testing works

In order to prove to the mission integrator that your CubeSat software will work as planned, you'll perform the DITL testing. The idea is to recreate what happens to your CubeSat when it's released from the dispenser. To do this, you will start by removing the RBF pin with the separation switch(es) depressed, just as if it were inside the dispenser. Then, to simulate the CubeSat being ejected, you will release the separation switch(es) and time how long it takes for the CubeSat to start transmitting and release its deployables. If this time is more than the minimum required in the ICD, the CubeSat meets that requirement.

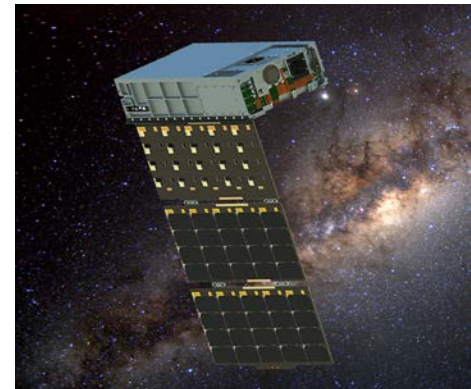

HaloSat, developed by the University of Iowa, is a science mission to map the distribution of hot gas in the Milky Way and to determine whether it fills an extended halo or the halo is compact with little contribution to the total mass of the galaxy. It will detect X-rays from oxygen ions in the hot Galactic halo. [Blue Canyon Technologies, Inc.]

There are two common types of dynamic testing: shock and vibration. Vibration testing (commonly referred to as vibrate testing) is required for all launches, but the launch vehicle provider does not always require shock testing. Testing can be done in your own testing facilities, but if you don't have the required capabilities, there are commercial testing facilities that you can work with for a price. Costs can sometimes be managed if multiple CubeSats on the same manifest can share the test setup simultaneously—such as during shock testing. If your organization has access to vibrate or shock testing facilities (through a connection to a local university, for example), that can be an inexpensive alternative to using a commercial facility.

Your environmental testing reports need to show that your CubeSat flight unit was tested to the levels prescribed in the CubeSat-to-dispenser ICD. It also needs to show that the CubeSat was structurally intact after testing (verified by visual inspection, and from responses of pre- and post- test sine sweeps), and that the CubeSat did not transmit or power-on in accordance with the ICD requirements.

The mission integrator will supply a template for the test procedure and report. The report must include the control/input data, response of the test article (if applicable), and pictures of the test setup, with special attention given to the accelerometer locations. Before testing can begin, the mission integrator needs to review your testing procedures to make sure the test will verify all of the appropriate ICD requirements.

➔ **After you've completed the environmental testing, you are not allowed to make any physical changes to the hardware (i.e., no removing panels, no unscrewing fasteners, no releasing deployables, etc.) for any reason.** Doing so will invalidate your test, and the mission integrator will require you to perform a retest and submit another test report.

Minimum Report Content

- As-run procedures with all steps time-stamped
- Photos of the test setup, including accelerometer locations
- Plots of the test data showing the test durations and levels
- Proof that the CubeSat survived testing



Salish Kootenai College student Zachary DuMontier tests solar panels on **BisonSat**. The BisonSat mission is an Earth Science mission that will demonstrate the acquisition of 100-meter or better resolution visible light imagery of Earth using passive magnetic stabilization from a CubeSat. BisonSat is the first CubeSat designed, built, tested, and operated by tribal college students. Launched by NASA's CubeSat Launch Initiative on the ELaNa XII mission as an auxiliary payload aboard the NROL-55 Mission on October 8, 2015. [Salish Kootenai College]

6.9.3 Thermal Vacuum Bakeout Testing

Bakeout

During the thermal vacuum (TVAC) bakeout test, the CubeSat is heated to prescribed temperatures while in a high-vacuum environment. This bakeout is required on almost all missions, primarily to allow the CubeSat's materials to outgas any possible contaminants before the actual launch. The primary payload is sometimes very sensitive to contaminants, and many materials will release small amounts of matter as the air pressure decreases to vacuum. Performing the bakeout ensures that any matter that would have been released during launch is safely released during the bakeout instead.

The ICD will state the required temperatures and target vacuum level that your CubeSat will need to be tested to, as well as how long the CubeSat needs to be at each temperature and vacuum level.

The test report needs to show that the CubeSat was subjected to thermal and vacuum levels in accordance with the CubeSat-to-dispenser ICD requirements. The mission integrator will supply a template for the test procedure and report. Your report must include the control/input data, response of the test article (if applicable), and pictures of the test setup, with special attention to thermocouple, or temperature sensor, locations. Before testing begins, the mission integrator needs to review your testing procedures to make sure the test will verify all of the appropriate ICD requirements.

Minimum Report Content

- Time-stamped logs to show proper temperature and vacuum levels were maintained
- Photos of the test setup, including thermocouple locations
- Plots of the test data showing the temperature levels and durations
- Plots of the test data showing the vacuum levels and durations
- Proof that the CubeSat survived testing

Cycling

Another type of TVAC testing is TVAC cycling. CubeSat developers aren't usually required to perform this type of testing on their CubeSat, but it can help screen for problems caused by the thermal cycling on orbit and help improve the odds of your mission's success. The reason you'll want to put your CubeSat (or even just the components) through TVAC cycling is to be confident that your



A student from Thomas Jefferson High School of Alexandria, Virginia conducting vibration testing on the **TJ3Sat** CubeSat. It was developed to create educational resources through which other K-12 institutions can learn about aerospace engineering and be encouraged to seek careers in the STEM fields. The primary payload is a voice synthesizer module that takes written phrases in the form of code and produces a phonetic voice reading on the satellite's downlink frequencies. Launched by NASA's CubeSat Launch Initiative on the ELaNa IV mission as an auxiliary payload aboard the U.S. Air Force-led Operationally Responsive Space (ORS-3) Mission on November 19, 2013. [Thomas Jefferson High School]

CubeSat can handle the vacuum and temperature range without being damaged. You'll want to know before you send your CubeSat to space that your solder joints won't break, and that the battery package isn't going to melt away. For testing levels and cycle repetitions, check out the CubeSat Requirements Document, LSP-REQ-317.01, which is available on the NASA Web site at https://www.nasa.gov/pdf/627972main_LSP-REQ-317_01A.pdf. It lays out a good guideline for this test.

TVAC cycling is typically just an internal test that you perform for yourself, so you probably won't be required to submit a report to the mission integrator. However, in the interest of good record keeping, you should still write up a report and procedures that your team can refer back to in the future.

WARNING!

Cycle testing is completely different from bakeout testing and cannot be performed in place of your bakeout.



6.10 Compliance Letter

The compliance letter is signed by the CubeSat **principal investigator**. The letter is essentially a statement from the CubeSat developer guaranteeing that your CubeSat is compliant with the entire CubeSat-to-dispenser ICD, and that no prohibited components are aboard.

The mission integrator will typically send a draft letter to the CubeSat teams for signature.

This deliverable is typically one of the last items due. A *generic example* is included in *Appendix C*.

principal investigator: The principal investigator (PI) is the official leader of the CubeSat project and is specified in the project's proposal. For university CubeSats, this position is filled by the faculty member who is most responsible for the project.

6.11 Safety Package Inputs (e.g., Missile System Prelaunch Safety Package, Flight Safety Panel)

Depending on the type of mission model the CubeSat is participating in, you will probably be required to submit documents with information specifically for range safety, such as the Missile System Prelaunch Safety Package (MSPSP) or the Flight Safety Panel (for Space Station missions).

The CubeSat developer typically is responsible for creating the MSPSP, but the mission integrator will create a template, with instructions, for the CubeSat teams to complete. In some cases, the mission integrator will write the MSPSP for the CubeSats, but that will still require detailed information from the CubeSat developer.

The document covers all the hazards that the CubeSat could pose to the LV, the dispenser, other CubeSats, and personnel handling or in proximity of the CubeSat. You will be required to complete the MSPSP early to support any LV provider analyses and ensure that your CubeSat design is safe to fly.

The mission integrator typically will supply a template to help the CubeSat developer create an MSPSP. The CubeSat MSPSP will outline any potential hazards and how each is mitigated. Your final MSPSP documentation generally needs to be submitted at least 45 days prior to arrival at the range, or launch facility. Your mission integrator will set a deadline well ahead of the official due date and will submit the MSPSP through the appropriate channels.

Appendices

A List of Abbreviations

ADCS	attitude determination and control system	ICD	Interface Control Document
AFSPCMAN	Air Force Space Command Manual	IRC	Internet Relay Chat
AFOSHSTD	Air Force Occupational Safety And Health Standard	ISS	International Space Station
AO	Announcement of Opportunity	ITU	International Telecommunication Union
APIC	Auxiliary Payload Integration Contractor	JSpOC	Joint Space Operations Center
CAC	CubeSat Acceptance Checklist	LSP	Launch Services Program
Cal Poly	California Polytechnic State University	LV	launch vehicle
CDS	CubeSat Design Specification	MOI	moment of inertia
CFR	Code of Federal Regulations	MRR	Mission Readiness Review
CG	center of gravity	MSPSP	Missile System Prelaunch Safety Package
CIR	CubeSat Interface Review	NASA	National Aeronautics and Space Administration
CONOPS	Concept of Operations	NEI	Non-Earth Imaging
CRADA	Cooperative Research And Development Agreement	NOAA	National Oceanic and Atmospheric Administration
CRSRA	Commercial Remote Sensing Regulatory Affairs	NRO	National Reconnaissance Office
CSLI	CubeSat Launch Initiative	NTIA	National Telecommunications and Information Administration
CVCM	collected volatile condensable materials	ODAR	Orbital Debris Assessment Report
DAS	Debris Assessment Software	ORS	Operationally Responsive Space
DITL	Day in The Life	OSL	Office of Space Launch
DOD	Department of Defense	PCB	printed circuit board
ELaNa	Educational Launch of Nanosatellites	P-POD	Poly-Picosatellite Orbital Deployer
ELV	Expendable Launch Vehicle	RBF	Remove Before Flight
EMI/EMC	electromagnetic interference/electromagnetic compatibility	RF	radio frequency
ETU	engineering test unit	RFP	Request for Proposal
EWR	Eastern and Western Range	SSDL	Space Systems Development Laboratory
FCC	Federal Communications Commission	TLE	Two Line Element
GSE	Ground Support Equipment	TML	total mass loss
IARU	International Amateur Radio Union	TNC	terminal node controller
		TVAC	thermal vacuum

Pictured above:

A set of NanoRacks CubeSats is photographed by an Expedition 38 crew member after the deployment by the NanoRacks Launcher attached to the end of the Japanese robotic arm. [NASA]

B Glossary

- Attitude Determination and Control Systems** The Attitude Determination and Control System (ADCS) is the system designed to stabilize and orient the CubeSat toward a given direction. This is a critical system for mission success. If the satellite needs to point its solar panels toward the Sun to get the most power possible or if you are taking images of the Earth its attitude has to be set to the correct value.
- breadboard** A breadboard is a board used to make an experimental model of components for testing.
- CubeSat Design Specification** The CubeSat Design Specification (CDS) is a set of general requirements for all CubeSats, but is not the official set of requirements that you will need to follow for your launch.
- CubeSat developer** You'll hear this term a lot in the CubeSat world. This is the standard term for any person or organization that is designing, building, and preparing a CubeSat for flight.
- deliverables** A deliverable is anything that your team has agreed to submit to the mission integrator as part of your legal obligations under the CRADA. These deliverables will be used to verify that your CubeSat meets the requirements set in the mission ICD. Chapter 6 describes the deliverables required on a typical CubeSat mission.
- electrical inhibit** An electrical inhibit is a physical device that interrupts the "power path" needed to turn on your CubeSat and/or other potentially hazardous devices.
- Engineering Test Unit** An engineering test unit (ETU) is built like the flight unit, but is not intended for launch. Developers will typically use the ETU like a practice dummy. It can be used to practice putting the components together, fit checks, hardware and software testing, and anything else that you don't want to try for the first time on your valuable flight unit.
- FlatSat** A FlatSat is exactly what it sounds like. It's an engineering unit of the CubeSat that includes all of the components, except the structure. Typically, the components are mounted on some sort of flat board, hence the term FlatSat. Developers can use the FlatSat to test and troubleshoot the CubeSat's systems without integrating everything onto the structure.
- form factor** This is a term used to describe the size, shape, and/or component arrangement of a particular device. When we use it in reference to the standard CubeSat, we're referring to the specific size and mass that defines a CubeSat.
- independent inhibit** An inhibit is a physical device between a power source and a hazard. A timer is not considered an independent inhibit.
- integration services** This normally includes, at a minimum, review of your deliverables, the dispenser, integrating your CubeSat into the dispenser, any testing that is done on the dispenser/CubeSat system, and physically integrating the dispenser/CubeSat system onto the launch vehicle.

- interface** “Interface” is a general term that refers to any point where two or more components are joined together. For instance, someone may ask, “How does the CubeSat interface with the dispenser?” or, “Is there an electrical interface between the CubeSat and the Dispenser?” (These questions mean, “Can I electrically connect the CubeSat to the dispenser somehow?”)
- investigation** This term gets used often when talking about a CubeSat’s mission. It refers to the investigation, scientific or otherwise, that your CubeSat will be performing. In this context, “investigation” is commonly used interchangeably with a CubeSat “mission.”
- manifesting** The process of assigning CubeSats to the available slots on a launch opportunity.
- margin** This is a very common term in the engineering world specifically referring to the safety margin, but is more generally used to refer to extra anything that gives you peace of mind. When you’re talking about scheduling, you add time, or margin, in case you run into issues or just estimate incorrectly.
- mission** This term is a somewhat generic, all-encompassing term that refers to the enterprise as a whole. It’s sometimes used interchangeably with “project” or “investigation” and includes all phases from development, testing, integration, to launch and operations.
- mission integrator** You may be asking yourself why the mission *integrator* isn’t called the mission *coordinator*. Well, sometimes they are. The terms “integration” and “coordination” when referring to a mission are commonly used interchangeably. For the purposes of this document, the person/organization responsible for the coordination will be referred to as “mission integrator,” and we’ll use “mission coordination” to refer to mission coordination activities.
- outgassing** In the spacecraft industry, outgassing refers to the sublimation or evaporation of materials as those materials are taken to a high-vacuum environment like space. The material that is lost to outgassing can find its way onto sensitive components and possibly affect a mission’s success.
- payload** In the aerospace industry, “payload” is a general term used to describe the cargo (e.g., a satellite or spacecraft) being delivered to space. When we’re talking about CubeSat dispensers, the payload always refers to the CubeSat.
- principal investigator** The principal investigator (PI) is the official leader of the CubeSat project and is specified in the project’s proposal. For university CubeSats, this position is filled by the faculty member who is most responsible for the project.
- range safety** Range safety is the person designed to protect people and assets on both the rocket launch range and downrange in cases when a launch vehicle might expose them to danger.
- Remove Before Flight pin** The Remove Before Flight (RBF) pin is a physical object that separates the CubeSat’s power system from the rest of the circuitry (particularly the central processor). Ideally, the RBF pin is removed after the CubeSat is integrated into the flight dispenser, but it can be removed just prior to integration.

- separation switches** The separation switches on the CubeSat are usually located on the ends of the CubeSat rails. When depressed (as they will be in the dispenser) they will physically separate the power system circuitry from the rest of the CubeSat circuitry. When the CubeSat is ejected from the dispenser into orbit, the switches will no longer be depressed and will allow the CubeSat circuitry to connect to the power system.
- SpaceCap Notice** The Space notification system PC Capture, or SpaceCap, is a software file containing information about transmitting stations in space, including details about antennas, transmitters, and the station itself. The file is created by PC-based software that can be downloaded for free from the International Telecommunications Union (ITU) Web site.
<http://www.itu.int>.
- strategic partnering** Sometimes a CubeSat mission is too ambitious for a single organization to undertake. In that case, a strategic partnership can combine the strengths and resources of multiple organizations to achieve greater goals. These strategic partnerships are typically formalized by some kind of formal agreement.
- Terminal Node Controller** The Terminal Node Controller (TNC) is a device used by amateur radio operators to participate in AX.25 packet radio networks. It will assemble the data into packets of information and key the transmitter to send the packets of data to the ground station. Once the ground station receives the packets, the packets are reassembled and encoded to a form that can be interpreted by your ground station.
- Two Line Elements** A Two Line Element (TLE) is a data format encoding a list of orbital elements of an Earth-orbiting CubeSat for a given point in time, the epoch. Using a prediction formula, a TLE can be used to estimate the position and velocity in the past, present or future for your CubeSat.

C Templates

1 ODAR Inputs

NASA Orbital Debris Assessment Report Inputs

ELaNa # ODAR

Satellite Name – Organization – Satellite Size

Insert expanded-view image here with labels for major components, pay particular attention to re-entry concern materials, if any (metals with high melting point, ceramics, glass, etc.). This can be the same image used in the **CubeSat Interface Review (CIR)**.

Brief Overview: Describe the satellite and mission objectives.

CONOPS: Give a rough description of activities from P-POD deployment to end of life. Mention any activities or deployments that may be of interest from an orbital debris standpoint.

Materials: Describe the major materials used in the satellite with particular attention to anything potentially capable of surviving reentry. Items listed here should agree with the ODAR spreadsheet.

Hazards: State whether there are any hazardous systems on the satellite.

Batteries: Describe the power system and make note of the UL listing number for the batteries. This is to provide confidence that the batteries have the proper safety mechanisms in place and will likely not create additional orbital debris.

Example submission is on the following page.

ELaNa II ODAR

CubeSat-1 – Example University – 1U

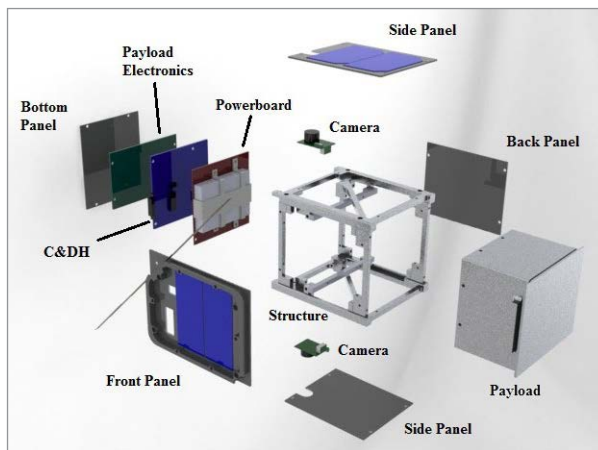

CubeSat-1 will demonstrate the use of commercial off-the-shelf (COTS) components in space, test a high-speed communications link, and characterize an Earth observation imager.

Upon deployment from the P-POD, CubeSat-1 will power up and start counting down timers. At 30 minutes, the antennas will be deployed, then at 45 minutes the UHF beacon will be activated. For the first few passes, the ground station operators will attempt communications to perform checkouts of the spacecraft. Approximately 4 days from launch, payload tests will begin and continue for at least 1 year.

The CubeSat structure is made of Aluminum 6061-T6. It contains all standard commercial off-the-shelf (COTS) materials, electrical components, PCBs, and solar cells. The high-speed radio uses a ceramic patch antenna.

There are no pressure vessels, hazardous, or exotic materials.

The electrical power storage system consists of common lithium-ion batteries with over-charge/current protection circuitry. The lithium batteries carry the UL-listing number MH12345.

2 CubeSat Components ODAR Template

NASA CubeSat Components ODAR Template

Row No.	Name	External/Internal (Major/Minor Components)	Qty	Material	Body Type	Mass (g)	Diameter/Width (mm)	Length (mm)	Height (mm)
1	CubeSat Name		1	e.g., Aluminum 6061	Box				
2	CubeSat Structure	External – Major	1	e.g., Aluminum 6061	Box				
3	Antennae	External – Major	xxx	e.g., Steel 410					
4	Solar Panels	External – Major		e.g., Fiberglass					
5	Sep Switches	External – Minor							
6	Any other external components	External – Minor							
7	Batteries	Internal – Major							
8	ADCS Components (e.g., Magnets)								
9	Payload Board								
10	Comm Board								
11	Battery Board								
12	C&DH Board								
13	Fasteners	Internal – Minor							
14	Cabling, etc.	Internal – Minor		e.g., Copper alloy					

Guide/Descriptions of Each Column

Row Number: List components in decreasing importance (follow column C)

Name: List your CubeSat first as the parent and each component and subsystem associated with your CubeSat

External/Internal: Rank CubeSat components from external to internal and major to minor

Qty: List the quantity of component

Material: List the parent material for the component, specify alloy type if possible

Body Type: List the general shape of the component

Mass: List the mass of the component in grams

Dimensions: List the width/length/height in millimeters

3 Transmitter Survey

All CubeSats shall provide transmitter data addressing the topics below, including their primary and secondary communications system (e.g., 70 cm and S-Band). This data shall satisfy the requirements set forth in the CubeSat-to-dispenser ICD.

- 1. Transmitter Type:** Enter the generic class of the transmitter. The general modulation type and transmitter purpose should be entered as a two- or three-word description. Examples are as follows: FM Communications, Pulse Doppler Radar, 802.11b Wireless LAN, FSK Data Communications, Spread-Spectrum Communications, etc.
- 2. Tuning Range:** Enter the frequency range (e.g., 225–400) and units (e.g., kHz, MHz or GHz) over which the transmitter is capable of being tuned. For equipment designed to operate only at a single frequency, enter this frequency. The entry should be the lowest tunable center frequency through the highest tunable center frequency. If the equipment is designed for use at a single frequency only, cannot be tuned, or in any way adjusted in frequency, the center frequency of the emission or reception should be listed in this block.
- 3. Filter Employed:** If a filter is employed between the final radio frequency (RF) stage and the transmitter antenna, it should be indicated here and information on the type of filter (e.g., lowpass, highpass, or bandpass) as well as any additional specifications should be provided here. An example of this additional information would be an entry such as this one: “Low-Pass filter with 1.5-dB insertion loss and a minimum of 85-dB attenuation 25 MHz removed from the tuned frequency.”
- 4. Emission Bandwidth:** This item should contain information regarding the spectral energy distribution of the transmitted signal. The emission bandwidth is defined as the signal appearing at the antenna terminals and includes any significant attenuation contributed by filtering in the output circuit or transmission lines. The bandwidths of the signals at points –3, –20, and –60 dB, relative to the fundamental signal level, are required, and should not include tuning range or carrier movement. The bandwidth at –40 dB shall also be entered if the transmitter is a pulsed radar transmitter. Values of emission bandwidth specified should be indicated as calculated or measured. Indicate units used (e.g., Hz, kHz, or MHz).

5. **Power (As-Deployed):** Enter the mean power delivered to the antenna terminals for all AM- and FM-type emissions as the satellite will be deployed on orbit. For all other classes of emissions, enter the peak envelope power (PEP). Any unique situations such as interrupted continuous wave (CW), should be provided in detail. Indicate the units (e.g., W or kW).
6. **Power (Maximum Hardware Capability):** Enter the mean power delivered to the antenna terminals for all AM- and FM-type emissions assuming maximum capability of the transmitter. For all other classes of emissions, enter the peak envelope power (PEP). Any unique situations, such as interrupted continuous wave (CW), should be provided in detail. Indicate the units (e.g., W or kW).
7. **Harmonic Level:** All RF transmitters emit energy at various places in the spectrum outside the necessary bandwidth. These out-of-band emissions are referred to as “spurious emissions.” The highest levels of spurious energy generally occur at frequencies that are multiples or “harmonics” of the center frequency. Thus, a transmitter tuned to 30 MHz will also emit energy on 60 MHz, 90 MHz, 120 MHz, etc. This section requires the second, third, and “other” harmonic power level specified in decibels relative to the peak output power of the carrier signal (dBc). The second harmonic emission falls at the frequency equal to two times the fundamental frequency. Similarly, the third harmonic falls at the frequency equal to three times the fundamental frequency. Harmonic emission power levels tend to decrease as the harmonic frequencies increase. Thus, the second harmonic power level is generally greater than the third, with the third expected to be greater than the fourth. The carrier signal, or fundamental emission, is always designated as 0 dB. Thus, a harmonic or spurious emission with a peak power of 80 dB below that of the fundamental has a relative level of -80 dBc. The level should always be expressed as a relative dB level, never as an absolute level (dBm or dBW). Whenever possible, the power levels should be measured from the radiated spectrum of the transmitter. If radiated spectrum measurements are not possible, the power levels should be measured at the antenna terminals. Indicate where the measurement was made (radiated, antenna terminals, or transmitter final stage).
8. **Spurious Level:** Enter the maximum value of spurious emission in dB relative to the fundamental, which occurs outside the -60 -dBc point on the transmitter fundamental emission spectrum but does not occur on a harmonic of the fundamental frequency.

4 Materials List

Launch Service Program – Standard Materials List Form

CubeSat Developer: _____

CubeSat Name: _____

Date Provided: _____

Purpose: The purpose of this document is to provide a listing of materials that have been selected for use in the CubeSats.

TABLE 1. Metals

Item #	Material ID	Specification	Description	% TML	% CVCM	Location	Data Reference

TABLE 2 – Non-Metal

Item #	Material ID	Specification	Description	% TML	% CVCM	Location	Data Reference

TABLE 3 – Surface Coatings

Item #	Material ID	Specification	Description	% TML	% CVCM	Location	Data Reference

TABLE 4 – Elastomerics

Item #	Material ID	Specification	Description	% TML	% CVCM	Location	Data Reference

TABLE 5 – Adhesives

Item #	Material ID	Specification	Description	% TML	% CVCM	Location	Data Reference

TABLE 6 – Miscellaneous

Item #	Material ID	Specification	Description	% TML	% CVCM	Location	Data Reference

Notes:

N/A Non-Applicable

N/D No Data Available

5 Compliance Letter

[Optional Header Logo]

[Insert Date]

[Mission Integrator POC Name]

[Mission Integrator Organization]

[Mission Integrator Address]

[Mission Integrator Address]

Dear _____,

This memo is to certify that *[Insert CubeSat Name]* and *[Insert CubeSat Team Name]* is in compliance with all requirements in the CubeSat to Dispenser Interface Control Document for the *[Insert Mission Name]* Mission *[Insert ICD doc ID#]*.

This compliance includes the following: *[ICD verification statements below are examples, insert statements specific to current mission ICD]*

- 3.1.1 CubeSat Design
 - The CubeSats shall be self-contained and provide their own power, sequencing, and wiring.
- 3.1.2 Pressure Vessels
 - The CubeSat shall not contain pressurized vessels.
- 3.1.3 Propulsion Systems
 - The CubeSat shall not contain propulsion systems.
- 3.1.4 Radioactive Material
 - The CubeSat shall not contain radioactive material that, unshielded, would produce personnel exposure greater than the Nuclear Regulatory Commission limit for members of the general public in any unrestricted area.
- 3.1.5 Explosive Devices
 - The CubeSat shall not contain explosive devices.

- 3.3.5.1 CubeSat Transmissions through Ground Command
 - The CubeSat operations plan shall prevent ground-commanded activation of any CubeSat transmissions prior to 45 minutes after on-orbit deployment from the P-POD.

For requirement 3.3.5.1 I certify that *[CubeSat Team Name]* ground operations procedures will restrict issuance of ground commands until 45 minutes after the confirmed separation time of the CubeSat from the P-POD.

Sincerely,

[Principal Investigator Signature Block]

[PI Name Typed]

[PI Title]

[Institution]

6 CubeSat Acceptance Checklists

1U CubeSat Acceptance Checklist

Project: _____ Date/Time: _____ Engineers: _____
 Organization: _____ Location: _____
 Satellite Name: _____ Satellite S/N: _____ *Revision Date: 02/20/2014*

Mass (< 1.33 kg)	_____	RBF Pin (≤ 6.5 mm)	_____
Spring Plungers (Depressed)	Functional Y / N Flush with Standoff Y / N	Rails Anodized	Y / N
Deployment Switches (Depressed)	Functional Y / N Flush with Standoff Y / N	Deployables Constrained	Y / N

Mark on the diagram the locations of the RBF pin, connectors, deployables, and any envelope violations.

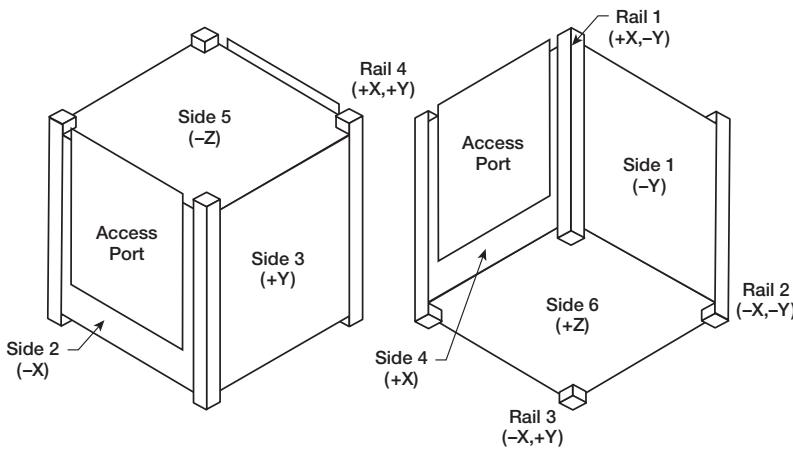

Authorized by:
 IT 1: _____
 IT 2: _____
 Passed: Y / N

List Item	As Measured				Required		
Width [x-y]	Side 1 (-Y)	Side 2 (-X)	Side 3 (+Y)	Side 4 (+X)			
+Z	_____	_____	_____	_____	100 ± 0.1 mm		
Middle	_____	_____	_____	_____	100 ± 0.1 mm		
-Z	_____	_____	_____	_____	100 ± 0.1 mm		
Height [x-y]	Rail 1 (+X, -Y)	Rail 2 (-X, -Y)	Rail 3 (-X, +Y)	Rail 4 (+X, +Y)			
	_____	_____	_____	_____	113.5 ± 0.1 mm		
+Z Standoffs	Rail 1 (+X, -Y) length x width	Rail 2 (-X, -Y) length x width	Rail 3 (-X, +Y) length x width	Rail 4 (+X, +Y) length x width			
	___ x ___	___ x ___	___ x ___	___ x ___	≥ 6.5 mm		
-Z Standoffs	___ x ___	___ x ___	___ x ___	___ x ___	≥ 6.5 mm		
Protrusions	Side 1 (-Y)	Side 2 (-X)	Side 3 (+Y)	Side 4 (+X)	Side 5 (-Z)	Side 6 (+Z)	
	_____	_____	_____	_____	_____	_____	≤ 6.5 mm

1.5U CubeSat Acceptance Checklist

Project: _____ Date/Time: _____ Engineers: _____
 Organization: _____ Location: _____
 Satellite Name: _____ Satellite S/N: _____ *Revision Date: 02/20/2014*

Mass (< 2.00 kg)	_____	RBF Pin (≤ 6.5 mm)	_____
Spring Plungers (Depressed)	Functional Y / N Flush with Standoff Y / N	Rails Anodized	Y / N
Deployment Switches (Depressed)	Functional Y / N Flush with Standoff Y / N	Deployables Constrained	Y / N

Mark on the diagram the locations of the RBF pin, connectors, deployables, and any envelope violations.

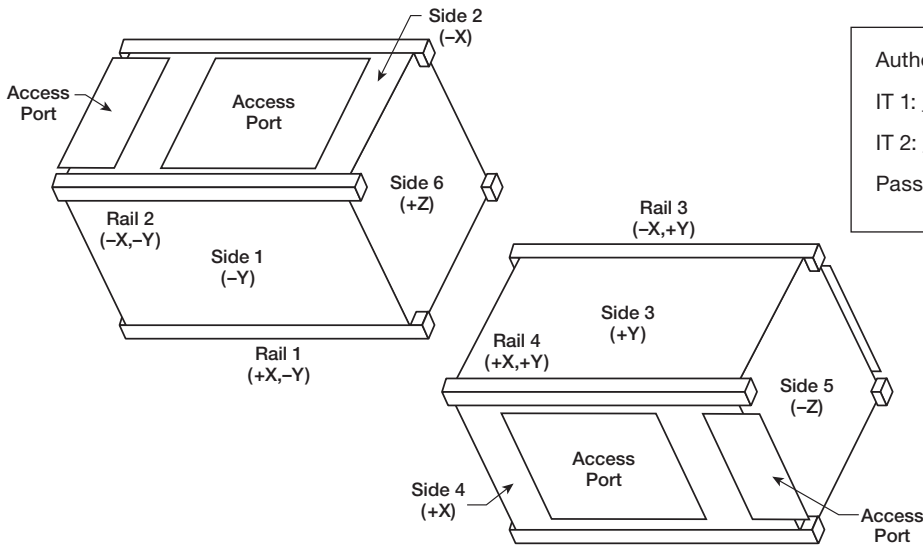

List Item	As Measured					Required	
Width [x-y]	Side 1 (-Y)	Side 2 (-X)	Side 3 (+Y)	Side 4 (+X)			
	+Z	_____	_____	_____	_____	100 ± 0.1 mm	
	Middle	_____	_____	_____	_____	100 ± 0.1 mm	
	-Z	_____	_____	_____	_____	100 ± 0.1 mm	
Height [x-y]	Rail 1 (+X, -Y)	Rail 2 (-X, -Y)	Rail 3 (-X, +Y)	Rail 4 (+X, +Y)			
	_____	_____	_____	_____		170.2 ± 0.1 mm	
+Z Standoffs	Rail 1 (+X, -Y) length x width	Rail 2 (-X, -Y) length x width	Rail 3 (-X, +Y) length x width	Rail 4 (+X, +Y) length x width			
	___ x ___	___ x ___	___ x ___	___ x ___		≥ 6.5 mm	
-Z Standoffs	___ x ___	___ x ___	___ x ___	___ x ___		≥ 6.5 mm	
Protrusions	Side 1 (-Y)	Side 2 (-X)	Side 3 (+Y)	Side 4 (+X)	Side 5 (-Z)	Side 6 (+Z)	
	_____	_____	_____	_____	_____	_____	
							≤ 6.5 mm

2U CubeSat Acceptance Checklist

Project: _____ Date/Time: _____ Engineers: _____
 Organization: _____ Location: _____
 Satellite Name: _____ Satellite S/N: _____ Revision Date: 02/20/2014

Mass (< 2.66 kg)	_____	RBF Pin (≤ 6.5 mm)	_____
Spring Plungers (Depressed)	Functional Y / N Flush with Standoff Y / N	Rails Anodized	Y / N
Deployment Switches (Depressed)	Functional Y / N Flush with Standoff Y / N	Deployables Constrained	Y / N

Mark on the diagram the locations of the RBF pin, connectors, deployables, and any envelope violations.

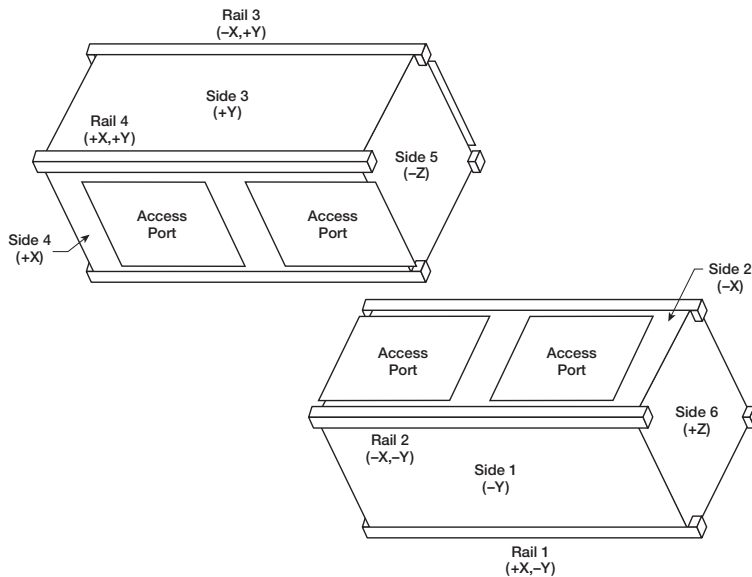

Authorized by:
 IT 1: _____
 IT 2: _____
 Passed: Y / N

List Item	As Measured				Required	
Width [x-y]	Side 1 (-Y)	Side 2 (-X)	Side 3 (+Y)	Side 4 (+X)		
	+Z	_____	_____	_____	100 ± 0.1 mm	
	Middle	_____	_____	_____	100 ± 0.1 mm	
	-Z	_____	_____	_____	100 ± 0.1 mm	
Height [x-y]	Rail 1 (+X, -Y)	Rail 2 (-X, -Y)	Rail 3 (-X, +Y)	Rail 4 (+X, +Y)		
	_____	_____	_____	_____	227.0 ± 0.2 mm	
+Z Standoffs	Rail 1 (+X, -Y) length x width	Rail 2 (-X, -Y) length x width	Rail 3 (-X, +Y) length x width	Rail 4 (+X, +Y) length x width		
	___ x ___	___ x ___	___ x ___	___ x ___	≥ 6.5 mm	
-Z Standoffs	___ x ___	___ x ___	___ x ___	___ x ___	≥ 6.5 mm	
Protrusions	Side 1 (-Y)	Side 2 (-X)	Side 3 (+Y)	Side 4 (+X)	Side 5 (-Z)	Side 6 (+Z)
	_____	_____	_____	_____	_____	_____

3U CubeSat Acceptance Checklist

Project: _____ Date/Time: _____ Engineers: _____
 Organization: _____ Location: _____
 Satellite Name: _____ Satellite S/N: _____ *Revision Date: 02/20/2014*

Mass (< 4.00 kg)	_____	RBF Pin (≤ 6.5 mm)	_____
Spring Plungers (Depressed)	Functional Y / N Flush with Standoff Y / N	Rails Anodized	Y / N
Deployment Switches (Depressed)	Functional Y / N Flush with Standoff Y / N	Deployables Constrained	Y / N

Mark on the diagram the locations of the RBF pin, connectors, deployables, and any envelope violations.

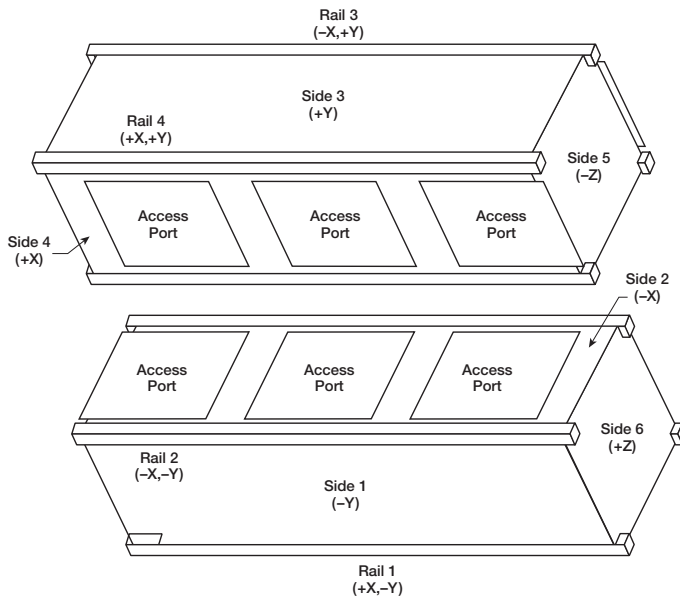

Authorized by:
 IT 1: _____
 IT 2: _____
 Passed: Y / N

List Item	As Measured				Required	
Width [x-y]	Side 1 (-Y)	Side 2 (-X)	Side 3 (+Y)	Side 4 (+X)		
	+Z	_____	_____	_____	100 ± 0.1 mm	
	Middle	_____	_____	_____	100 ± 0.1 mm	
-Z	_____	_____	_____	_____	100 ± 0.1 mm	
Height [x-y]	Rail 1 (+X, -Y)	Rail 2 (-X, -Y)	Rail 3 (-X, +Y)	Rail 4 (+X, +Y)		
	_____	_____	_____	_____	340.5 ± 0.3 mm	
+Z Standoffs	Rail 1 (+X, -Y) length x width ___ x ___	Rail 2 (-X, -Y) length x width ___ x ___	Rail 3 (-X, +Y) length x width ___ x ___	Rail 4 (+X, +Y) length x width ___ x ___	≥ 6.5 mm	
-Z Standoffs	_____	_____	_____	_____	≥ 6.5 mm	
Protrusions	Side 1 (-Y)	Side 2 (-X)	Side 3 (+Y)	Side 4 (+X)	Side 5 (-Z)	Side 6 (+Z)
	_____	_____	_____	_____	_____	_____

3U+ CubeSat Acceptance Checklist

Project: _____ Date/Time: _____ Engineers: _____
 Organization: _____ Location: _____
 Satellite Name: _____ Satellite S/N: _____ *Revision Date: 02/20/2014*

Mass (< 4.00 kg)	_____	RBF Pin (≤ 6.5 mm)	_____
Spring Plungers (Depressed)	Functional Y / N Flush with Standoff Y / N	Rails Anodized	Y / N
Deployment Switches (Depressed)	Functional Y / N Flush with Standoff Y / N	Deployables Constrained	Y / N

Mark on the diagram the locations of the RBF pin, connectors, deployables, and any envelope violations.

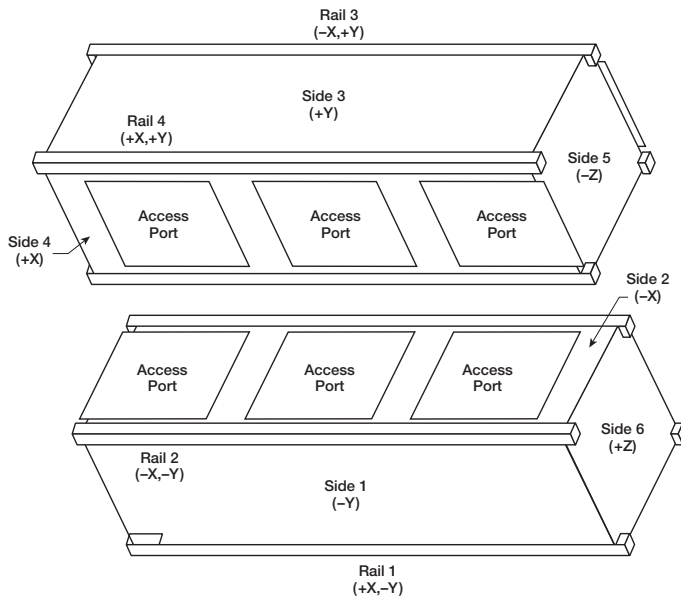

Authorized by:
 IT 1: _____
 IT 2: _____
 Passed: Y / N

3U+ Volume
 Length (Z): ____ ≤ 36 mm
 Diameter: ____ ≤ 64 mm
 3U+ Centered: Y / N

List Item	As Measured				Required	
Width [x-y]	Side 1 (-Y)	Side 2 (-X)	Side 3 (+Y)	Side 4 (+X)		
	+Z	_____	_____	_____	100 \pm 0.1 mm	
	Middle	_____	_____	_____	100 \pm 0.1 mm	
-Z	_____	_____	_____	_____	100 \pm 0.1 mm	
Height [x-y]	Rail 1 (+X, -Y)	Rail 2 (-X, -Y)	Rail 3 (-X, +Y)	Rail 4 (+X, +Y)		
	_____	_____	_____	_____	340.5 \pm 0.3 mm	
+Z Standoffs	Rail 1 (+X, -Y)	Rail 2 (-X, -Y)	Rail 3 (-X, +Y)	Rail 4 (+X, +Y)		
	length x width	length x width	length x width	length x width		
+Z Standoffs	____ x ____	____ x ____	____ x ____	____ x ____	≥ 6.5 mm	
-Z Standoffs	____ x ____	____ x ____	____ x ____	____ x ____	≥ 6.5 mm	
Protrusions	Side 1 (-Y)	Side 2 (-X)	Side 3 (+Y)	Side 4 (+X)	Side 5 (-Z)	Side 6 (+Z)
	_____	_____	_____	_____	_____	_____

D Technical Reference Documents for CubeSat Requirements

Range

Document Number	Title
AFOSHSTD 48-9 Air Force Occupational Safety and Health Standard	Radio Frequency Radiation (RFR) Safety Program
AFSPCMAN 91-710 Air Force Space Command Manual	Launch Vehicles, Payloads, and Ground Support Systems Requirements
EWR 127-1 Eastern and Western Range	Range Safety Requirements, Range User Handbook

NASA Standards and Specifications

Document Number	Title
NASA-STD-6016 NASA Technical Standards Program	Standard Materials and Processes Requirements for Spacecraft
NASA-STD-8719.14A	Process for Limiting Orbital Debris
NPR 8715.6A	NASA Procedural Requirements for Limiting Orbital Debris Generation

Standards and Specifications

Document Number	Title
Air Force Memo 4 May 2005	Joint 45 SW/SE and 30 SW/SE Interim Policy Regarding EWR 127-1 Requirements for System Safety for Flight and Aerospace Ground Equipment Lithium-Ion Batteries
GSFC-STD-7000 A	General Environmental Verification Standard for GSFC Flight Programs and Projects
MIL-STD-461F	Electronic Emission and Susceptibility Requirements for the Control of Electromagnetic Interference and Notices 1 and 2 dated 4/08/1986, 4/01/1987 and 10/15/1987 respectively
SMC-S-016	Space and Missile Systems Center Standard Test Requirements for Launch, Upper-Stage, and Space Vehicles
UL 1642	UL Standard for Safety for Lithium Batteries
UL 2054	UL Standard for Safety for Household and Commercial Batteries

E Notional Timeline of Events/Deliverables

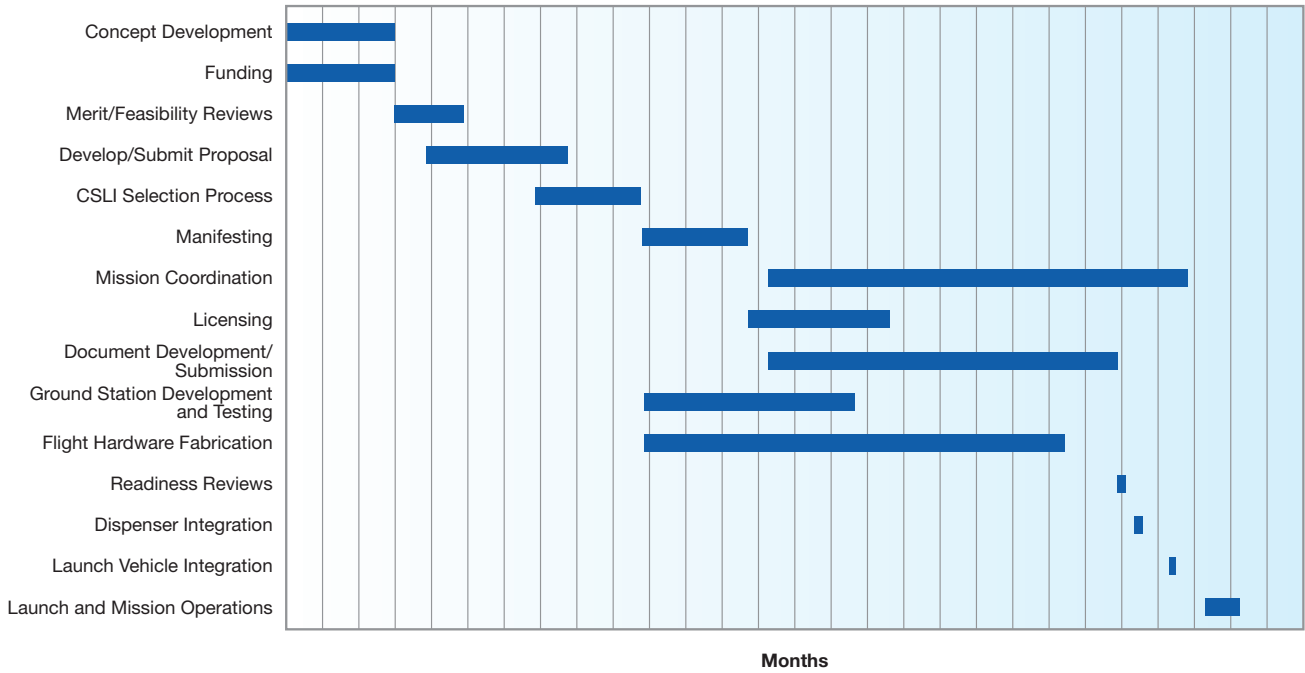

This notional timeline shows how these phases might come together for a project.

Cover Image Credits

Front Cover

Top: Launch of NASA's NPOESS Preparatory Project (NPP) mission on Oct. 28, 2011 which deployed five CubeSats as part of the Educational Launch of the Nanosatellite (ELaNa)-III Mission. [U.S. Air Force/Staff Sgt. Andrew Satran]

Left: Students Alex Diaz and Riki Munakata of California Polytechnic State University testing the **LightSail** CubeSat. LightSail is a citizen-funded technology demonstration mission sponsored by the Planetary Society using solar propulsion for CubeSats. [The Planetary Society]

Middle: **ChargerSat-1**'s mission was developed by students from the University of Alabama, Huntsville to conduct three technology demonstrations: a gravity gradient stabilization system will passively stabilize the spacecraft; deployable solar panels will nearly double the power input to the spacecraft; and the same deployable solar panels will shape the gain pattern of a nadir-facing monopole antenna, allowing improved horizon-to-horizon communications. [University of Alabama, Huntsville]

Right: **CAPE-2** was developed by students from the University of Louisiana Lafayette to engage, inspire and educate K-12 students to encourage them to pursue STEM careers. The secondary focus is the technology demonstration of deployed solar panels to support the following payloads: text to speech, voice repeater, tweeting, email, file transfer and data collection from buoys. [University of Louisiana at Lafayette]

Back Cover

Top: A set of CubeSats is photographed by an Expedition 38 crew member after the deployment by the NanoRacks Launcher attached to the end of the Japanese robotic arm affixed to the Space Station. [NASA]

Left: Students Sergei Posnov, David Einhorn, Thompson Cragwell, and Maria Kromis working on the **ANDESITE** CubeSat from Boston University. ANDESITE will measure small-scale spatial magnetic features in the auroral current systems. The measurements will be made through a constellation of picosatellites deployed by the main payload and communicating over a mesh network. [Boston University]

Middle: The **BisonSat** mission is an Earth Science mission that will demonstrate the acquisition of 100-meter or better resolution visible light imagery of Earth using passive magnetic stabilization from a CubeSat. BisonSat is the first CubeSat designed, built, tested, and operated by tribal college students. Launched by NASA's CubeSat Launch Initiative on the ELaNa XII mission as an auxiliary payload aboard the NROL- 55 Mission on October 8, 2015. [Salish Kootenai College]

Right: University of Kentucky students Jason Rexroat and Alex Clements working on **KySat-2** a technology demonstration CubeSat mission developed by students from the University of Kentucky in Lexington, Kentucky that builds upon KySat-1 by expanding the K-12 outreach goals to interest students to science, technology, engineering and mathematics (STEM) fields and space technology. It also will test components of a novel attitude determination system called a Stellar Gyroscope that uses sequences of digital pictures to determine the three-axis rotation rate of the satellite. Launched by NASA's CubeSat Launch Initiative on the ELaNa IV mission as an auxiliary payload aboard the U.S. Air Force- led Operationally Responsive Space (ORS-3) Mission on November 19, 2013. [University of Kentucky]

